

Design of Microstrip Parallel-Coupled Lines with High Directivity using Symmetric-Centered Inductors

Somchat Sonasang¹ and Niwat Angkawisittpan^{2*}

¹Department of Electrical Engineering, Faculty of Engineering, Mahasarakham University
Maha Sarakham 44150, Thailand
somchat.sonasang@gmail.com

²Research Unit for Computational Electromagnetics and Optical Systems, Faculty of Engineering
Mahasarakham University, Maha Sarakham 44150, Thailand
*niwat.a@msu.ac.th

Abstract — A technique for directivity improvement of the microstrip parallel-coupled lines using symmetric-centered inductors is presented in this paper. The design procedure of the symmetric-centered inductors using the closed-form equations is given. The proposed technique was performed with a design at the operating frequency of 0.9 GHz on an FR4 substrate. Validity of the proposed technique is verified by simulations and measurements in comparisons with conventional parallel-coupled lines. The measured results exhibit the isolation of -30.10 dB and directivity of 19.28 dB at the operating frequency of 0.9 GHz. The directivity from the measured results is improved by more than 4 dB at 0.9 GHz and more than 6 dB at 1.05 GHz compared with the conventional parallel-coupled lines. In addition, the proposed technique for the microstrip parallel-coupled line can achieve a high directivity with the compact size (21.0 mm x 4.70 mm). The novelty of this paper is by introducing the proposed and closed-form design equations for the compact symmetric-centered inductors with high directivity.

Index Terms — Microstrip, parallel-coupled lines, directivity, symmetric-centered inductors.

I. INTRODUCTION

Microstrip parallel-coupled lines are often used as a passive element in microwave applications such as Wilkinson power dividers, Baluns [1], mixers, phase shifters, wideband bandpass filters [2], and feeding networks for antennas [3]. However, microstrip parallel-coupled lines also possess unwanted effects from inhomogeneous dielectric substrate due to inequity in the phase velocity of the even and odd modes. Various compensation techniques have been reported for improving the isolation and enhancement of directivity for microstrip parallel-coupled lines. The principal techniques can be classified into two main categories

including distributed [4-9] and lumped [10-19] compensation approaches. Lumped compensation approaches can further be classified into two well-known techniques including capacitive techniques [11-14], which are used for enhancement of directivity and inductive compensation techniques [15-19] presented are compensated by inductance for enhancement of high directivity microstrip parallel-coupled lines. However, the capacitive techniques require placement in a narrow spacing of the microstrip parallel-coupled lines. Nonetheless, there are drawbacks of parasitic effects in the ground connected and difficulty in layout. In addition, the compound techniques do not decrease the electrical length in the microstrip parallel-coupled lines. compensation technique [20] uses inductance and capacitance for directivity enhancement. Also, the technique requires the large physical size. However, the aforementioned.

The disadvantage of some approaches is the lack of closed-form design equations for additional impedances and electrical length. Also, it turns out that the design process heavily relies on the electromagnetic simulation step. This step consumes much computing time. In addition, some techniques are often not suitable for some standard fabrication tasks or require much space for the design devices, thus more cost demand is certainly required. Distinct advantage of the lumped compensation approach is its easy design process because the design equations can be derived [15].

In this paper, a simple, yet effective lumped compensation technique with symmetric-centered inductors is proposed. This technique can achieve enhancement of directivity, isolation improvement, and compact circuit size for microstrip parallel-coupled lines using symmetric-centered inductors. The closed-form equations for the design of symmetric-centered inductors and the equations for electrical length are proposed for improving the directivity and the isolation of the

microstrip parallel-coupled lines in this paper. In addition, the high directivity and isolation improvement can be obtained in the wider frequency range. In this paper, section II presents the theory for microstrip parallel-coupled lines with the proposed technique. The design equations for the proposed circuit are also given. Section III proposes the concept for the design of the symmetric-centered inductors and the simulated results for the microstrip parallel-coupled lines. Section IV shows the experimental results of the proposed technique. Finally, the conclusions are presented in Section V.

II. THE PROPOSED TECHNIQUE WITH SYMMETRIC-CENTERED INDUCTORS

The schematic of the proposed microstrip parallel-coupled lines is shown in Fig. 1 (a), in which the component has an input port (port 1), a coupled port (port 2), an isolated port (port 3) and a through port (port 4). The symmetric-centered inductors shown in Fig. 1 (b) are face to face configuration, consisting of microstrip parallel-coupled lines and symmetric-centered inductors (L_{sd}).

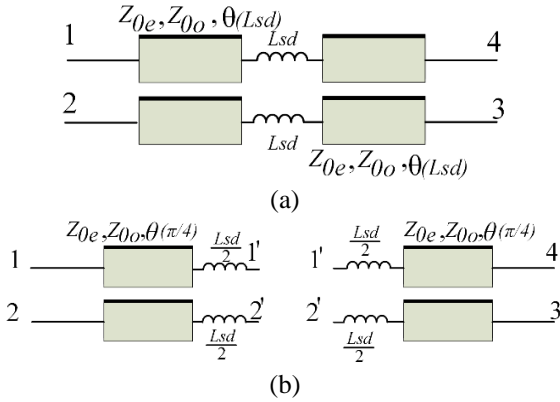

Fig. 1. Schematics of the proposed microstrip parallel-coupled lines with (a) the proposed technique and (b) face to face configuration.

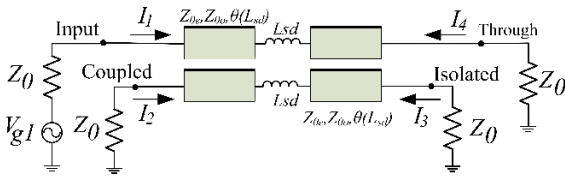

Fig. 2. Electrical schematic of the symmetric-centered inductors for microstrip parallel-coupled lines.

Figure 2 shows the electrical schematic of the symmetric-centered inductors for the microstrip parallel-coupled lines. This schematic was used for analysis of the various coefficients with the network theory.

Generally, the symmetric-centered inductors can be represented in terms of their corresponding two-port network. The equations are expressed by [15,16]:

$$V_1 = I_1 Z'_{11} + I_2 Z_{12} + I_3 Z_{13} + I_4 Z_{14}, \quad (1)$$

$$V_2 = I_1 Z_{21} + I_2 Z'_{22} + I_3 Z_{23} + I_4 Z_{24}, \quad (2)$$

$$V_3 = I_1 Z_{31} + I_2 Z_{32} + I_3 Z'_{33} + I_4 Z_{34}, \quad (3)$$

$$V_4 = I_1 Z_{41} + I_2 Z_{42} + I_3 Z_{43} + I_4 Z'_{44}, \quad (4)$$

where the $Z'_{11} = Z_{11} + Z_{Lsd}$ and $Z'_{22} = Z_{22} + Z_{Lsd}$ in these equations (1-4) have impedance parameters as follows [21]:

$$Z_{11} = -\frac{j}{2}(Z_{0e} \coth \theta_e + Z_{0o} \coth \theta_o), \quad (5)$$

$$Z_{12} = -\frac{j}{2}(Z_{0e} \coth \theta_e - Z_{0o} \coth \theta_o), \quad (6)$$

$$Z_{13} = -\frac{j}{2}(Z_{0e} \operatorname{csch} \theta_e - Z_{0o} \operatorname{csch} \theta_o), \quad (7)$$

$$Z_{14} = -\frac{j}{2}(Z_{0e} \operatorname{csch} \theta_e + Z_{0o} \operatorname{csch} \theta_o), \quad (8)$$

and the Z_{0e}, Z_{0o} are the even and odd mode characteristic impedances and θ_e, θ_o are even and odd mode electrical lengths, respectively. The even and odd mode electrical lengths are:

$$\theta_e = j \frac{\pi}{4}, \quad (9)$$

$$\theta_o = j \frac{\pi}{4} \sqrt{\frac{\epsilon_{effo}}{\epsilon_{effe}}}, \quad (10)$$

where $\epsilon_{effe}, \epsilon_{effo}$ are the even and odd mode effective relative dielectric constants. The phase velocities of the even and odd modes are different in microstrip parallel-coupled lines. Let the symmetric-centered inductors for the microstrip parallel-coupled lines become equal. The impedance parameters (Z) are in the equations (11-14) [21]:

$$Z_{11} = Z_{22} = Z_{33} = Z_{44}, \quad (11)$$

$$Z_{12} = Z_{21} = Z_{34} = Z_{43}, \quad (12)$$

$$Z_{13} = Z_{24} = Z_{31} = Z_{42}, \quad (13)$$

$$Z_{14} = Z_{23} = Z_{32} = Z_{41}. \quad (14)$$

Let the isolation coefficient (S_{31}) reach zero ($S_{31} \rightarrow 0$) for perfect isolation performance. The coupling coefficient (S_{21}), isolation coefficient (S_{31}) and the directivity can be derived and shown in the equations (15-17):

$$S_{21} = 20 \log \left(\frac{V_2}{V_1} \right), \quad (15)$$

$$S_{31} = 20 \log \left(\frac{V_3}{V_1} \right), \quad (16)$$

$$Directivity = 20 \log \left(\frac{V_2}{V_3} \right) = S_{21} - S_{31}. \quad (17)$$

The symmetric-centered inductors are connected at the center of the microstrip parallel-coupled lines. The equations (1-17) are used to determine the isolation coefficients in terms of coupler electrical parameters, which can be derived as the mentioned symmetric-centered inductors. Furthermore, the directivity can be improved at the operating frequency (f_o) as soon as the isolation coefficient is null. The impedance of symmetric-centered inductors is obtained in the function of Z-impedance in equation (18) as:

$$Z_{Lsd} = - \frac{\left(Z_{11}^2 Z_{13} + 2Z_{11}Z_{13}Z_0 - 2Z_{11}Z_{12}Z_{14} + Z_{13}^2 Z_0 - Z_{13}^3 + Z_{13}Z_{14}^2 - 2Z_{12}Z_{14}Z_0 \right)}{Z_{11}Z_{13} + Z_{13}Z_0 - Z_{12}Z_{14}}, \quad (18)$$

then the symmetric-centered inductors are as the equation (19):

$$L_{sd} = \frac{1}{2\pi f_o} \operatorname{Im} \left(\frac{Z_{0o}Z_{0e}^2 - Z_{0e}Z_{0o}^2 + Z_0^2 \sinh \theta_o + Z_0^2 \sinh \theta_e - 2Z_0^3 \varphi}{Z_o Z_{0e} \sinh \theta_o + Z_{0o} \sinh \theta_e - Z_o^2 \varphi} \right), \quad (19)$$

where $\varphi = \cosh \theta_e - \cosh \theta_o$ and Z_0 is the characteristic impedance of the coupled lines, $\theta_e = \pi/4$ is the even mode electrical length, and $\theta_o = (\pi/4)k$ is the odd mode electrical length of the coupled lines when $k = \sqrt{\epsilon_{effo}/\epsilon_{effe}}$. The equation (19) proposes a closed-form expression to design the symmetric-centered inductors for high directivity at the desired frequency. For

the microstrip parallel-coupled lines with symmetric-centered inductors, the isolation coefficient can reach zero if the new electrical length $\theta(L_{sd})$ is as follows:

$$\theta(L_{sd}) = \frac{\cot^{-1} \left(\frac{4\pi f_o L_{sd} + Z_{0e} \cot \theta_e + Z_{0o} \cot \theta_o}{2Z_{0e}} \right)}{\pi}. \quad (20)$$

III. DESIGN AND SIMULATED RESULTS OF THE SYMMETRIC-CENTERED INDUCTORS

To validate the performance of the proposed technique, a 10-dB conventional parallel-coupled line and the proposed parallel-coupled line operating at the operating frequency of 0.9 GHz are designed and simulated. An FR4 substrate ($h=1.6$ mm, $\epsilon_r = 4.55$, and $\tan \delta = 0.02$) is used for both parallel-coupled lines. The symmetric-centered inductors are designed and determined from the equations (18-19). The calculation of the symmetric-centered inductors from equation

(19) and the electrical length $\theta(L_{sd})$ from equation (20) are 3.3 nH and 0.22π rad, respectively. These physical parameters of the symmetric-centered inductors and the conventional parallel-coupled lines are shown in Table 1. The topologies of the conventional parallel-coupled lines and the proposed parallel-coupled lines are shown in Figs. 3 (a) and 3 (b), respectively.

Table 1: Parameters of the conventional parallel-coupled lines and the proposed parallel-coupled lines

Technique	Components	$\theta(rad)$	W,S,L (mm)
Conventional coupled lines	-	0.25π	2.25, 0.2, 23.4
Symmetric-centered inductors	$L_{sd} = 3.3$ nH Transmission line (W,L) = 0.4, 1.3 mm	0.22π	2.25, 0.2, 21

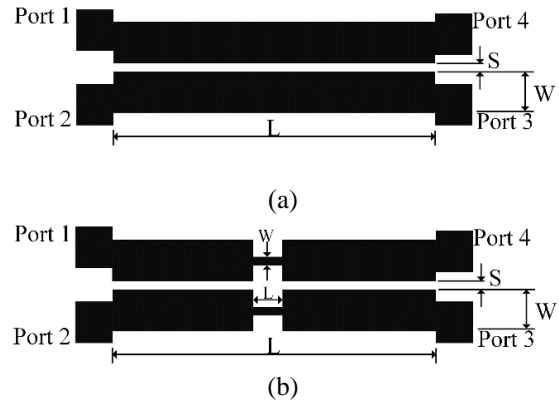

Fig. 3. Schematics of the parallel-coupled lines: (a) conventional parallel-coupled lines, and (b) the proposed parallel-coupled lines.

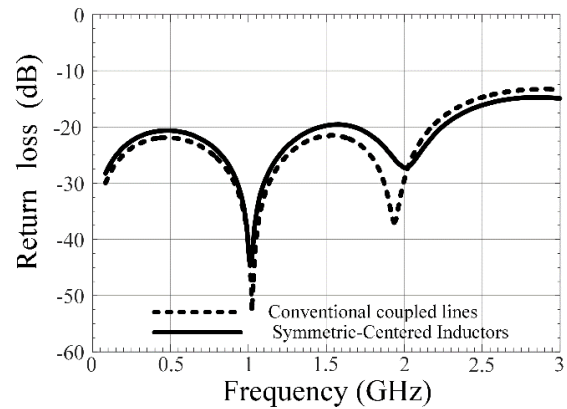

Fig. 4. Simulated results of return loss for the conventional coupled lines and the proposed parallel-coupled lines.

In Figs. 4, 5, 6, and 7, the EM simulated results [22] of the conventional microstrip parallel-coupled lines, and the proposed parallel-coupled lines are shown, including return loss, coupling factor, isolation, and directivity. The simulated results of the return loss are less than -20 dB at the operating frequency of 0.9 GHz and the second harmonic frequency of 1.8 GHz, as seen in Fig. 4. In addition, the coupling factor is 10 dB at the operating frequency of 0.9 GHz for both coupled lines, as shown in Fig. 5. The isolation performance at the operating frequency of 0.9 GHz is less than -23.9 dB for both parallel-coupled lines, as shown in Fig. 6. In Fig. 7, the directivity of the proposed parallel-coupled lines at the operating frequency of 0.9 GHz is 14.8 dB. The proposed design achieves an improvement of 1.4 dB compared with the conventional parallel-coupled lines.

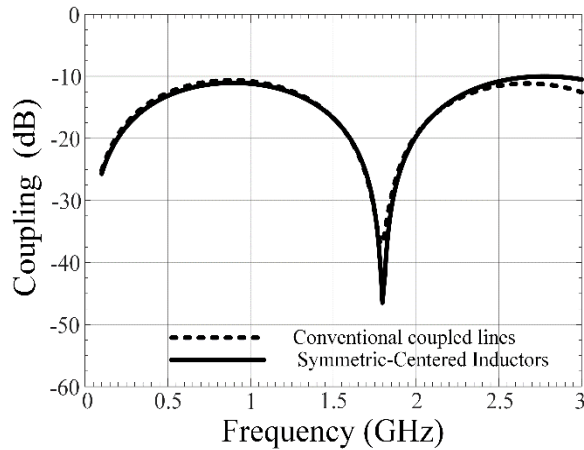

Fig. 5. Simulated results of coupling factor for the conventional coupled lines and the proposed parallel-coupled lines.

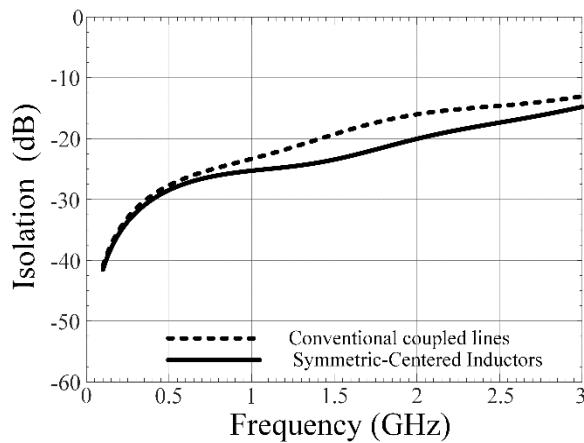

Fig. 6. Simulated results of isolation for the conventional coupled lines and the proposed parallel-coupled lines.

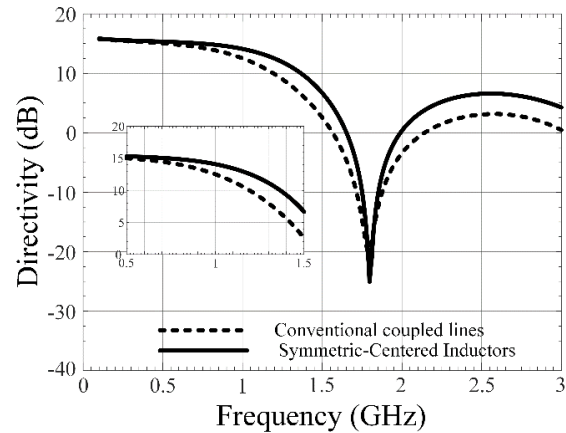

Fig. 7. Simulated results of directivity for the conventional coupled lines and the proposed parallel-coupled lines.

IV. EXPERIMENTAL RESULTS

Measurements are performed to validate the directivity of the proposed parallel-coupled lines. The results are compared with the results of conventional parallel-coupled lines. The prototypes are designed and fabricated on the FR4 substrate. PCB photographs of the conventional and proposed circuits are shown in Fig. 8. In addition, the electrical length (θ) is reduced from 0.25π to 0.22π as in Table 1.

Measurements are performed using the E5071C network analyzer calibrated from 0.1 to 3.0 GHz. Figure 9 shows measured return loss of the proposed parallel-coupled lines compared with the conventional parallel-coupled lines in the frequency range of 0.1 to 3.0 GHz. At the operating frequency of 0.9 GHz, the return losses of both parallel-coupled lines are lower than -20 dB. It is confirmed that the reflected power is low at the operating frequency. The coupling coefficients are about -10 dB at the operating frequency for both parallel-coupled lines as design. The measured results are shown in Fig. 10. The measured isolation performance obtained from the proposed parallel-coupled lines is -30.10 dB. It is about 2.17 dB, which is better than that of the conventional parallel-coupled lines from 0.1 to 3.0 GHz as shown in Fig. 11. In Fig. 12, the measured directivity at the operating frequency of the proposed and conventional parallel-coupled lines are 19.28 dB and 15.00 dB, respectively. It shows that the proposed technique provides directivity performance about 4.28 dB, which is better than that of the conventional technique. However, the highest directivity performance obtained from the proposed technique is 19.8 dB at the frequency of 1.05 GHz. At the frequency of 1.05 GHz, the proposed technique obtained a 6.05 dB improvement in directivity performance. Tables 2, 3 and 4 summarize the performances of the previous and proposed techniques. It is observed that the

electrical length equation and closed-form equation for the symmetric-centered inductors can be achieved. The proposed structure is easily fabricated. The frequency range of the proposed technique with higher directivity compared to the conventional techniques is wider than those of previous techniques. In addition, the proposed technique requires compact circuit size compared to the sizes of the previous techniques.

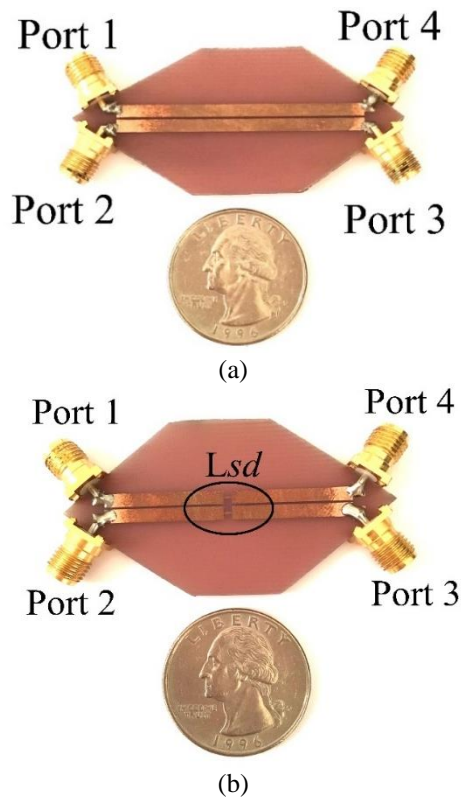

Fig. 8. Photographs of fabricated circuits: (a) conventional coupled lines and (b) proposed coupled lines.

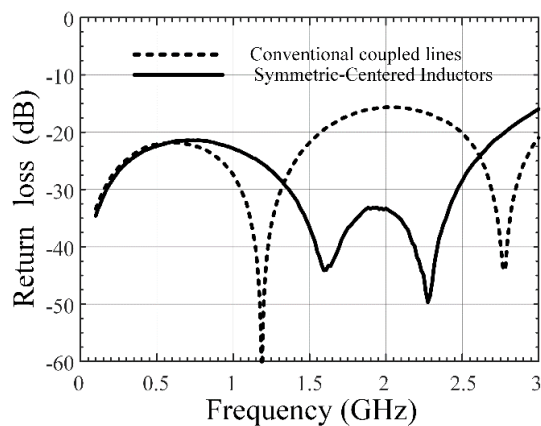

Fig. 9. Measured results for return loss of both parallel-coupled lines.

Table 2: Fabrication and electrical length equation comparison of inductive compensation for parallel-coupled lines

Ref.	Operating Frequency (GHz)	Electrical Length Equation	Fabrication
[17]	0.9	No	Complicated
[18]	2.4	No	Complicated
[20]	1.6	No	Complicated
This work	0.9	Yes	Easy

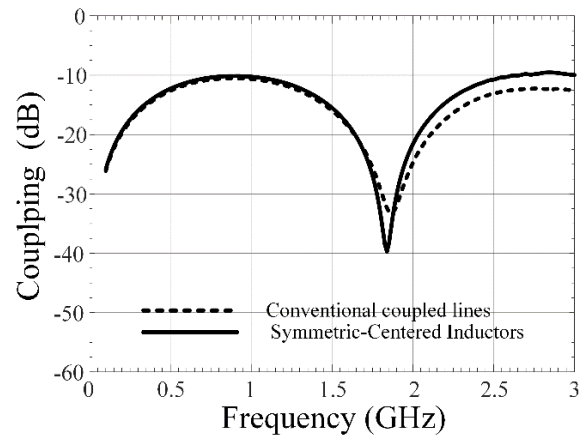

Fig. 10. Measured results for the coupling factors of both parallel-coupled lines.

Table 3: Frequency range with higher directivity comparison of inductive compensation for parallel-coupled lines

Ref.	Operating Frequency (GHz)	Frequency Ranges with Higher Directivity (Compared to Conventional Technique) (GHz)
[17]	0.9	0.1-2.0
[18]	2.4	2.0-2.8
[20]	1.6	1.2-2.0
This work	0.9	0.1-3.0 (wider)

Table 4: Size comparison of inductive compensation for parallel-coupled lines

Ref.	Operating Frequency (GHz)	Size (mm x mm)
[17]	0.9	53.40 x 23.13
[18]	2.4	18.39 x 18.31
[20]	1.6	19.90 x 18.60
This work	0.9	21.00 x 4.70

V. CONCLUSIONS

A technique using the symmetric-centered inductors has been proposed to enhance the directivity performance of microstrip parallel-coupled lines in this paper. The

design of the symmetric-centered inductors is simplified using the closed-form equations. The electrical length is also given. The simulated and measured results are used to validate the proposed technique. Since there are many microwave communication circuits whose circuits consist of microstrip parallel-coupled lines, it is believed that the proposed technique can be easily modified for use in modern wireless communications such as microwave resonators, couplers, and filters with compact size requirements.

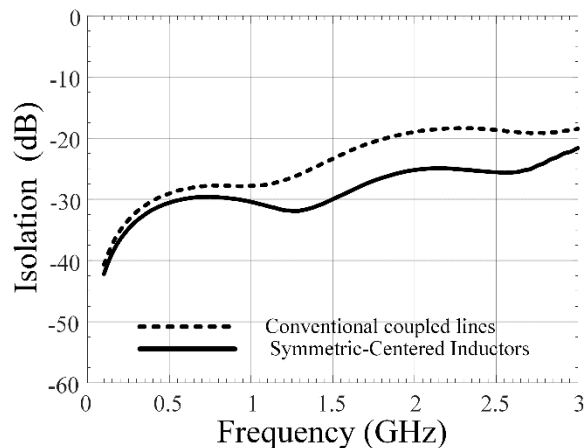

Fig. 11. Measured results for isolation performance of both parallel-coupled lines.

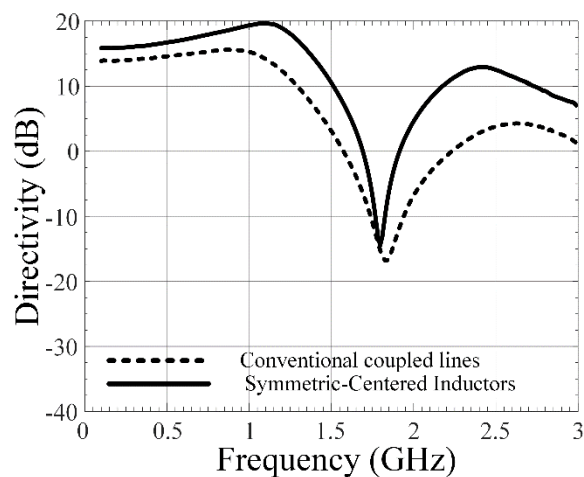

Fig. 12. Measured results for directivity performance of both parallel-coupled lines.

ACKNOWLEDGMENTS

This work was financially supported by Mahasarakham University, Maha Sarakham University, Thailand with the budget year of 2015. Gratitude is extended to Computational Electromagnetics and Optical Systems (CEMOS), Faculty of Engineering,

Mahasarakham University, Maha Sarakham, Thailand for the experiments. The authors are grateful to acknowledge Asst. Prof. Ravee Phromlounsri, Udon Thani Rajabhat University, Thailand for his usefulness suggestions.

REFERENCES

- [1] H. Ma, J. Lu, Y. Li, L. Liu, and J. Wang, "Design of a compact wideband balun bandpass filter with high selectivity," *Appl. Comput. Electromagn. Soc. J.*, vol. 31, no. 4, pp. 396-400, Apr. 2016.
- [2] C. Shao, Y. Li, L. Wang, and C. Jin, "Compact wideband parallel-coupled microstrip line bandpass filter with in-line structure," *Appl. Comput. Electromagn. Soc. J.*, vol. 32, no. 2, pp. 153-157, Feb. 2017.
- [3] S. Kim and J. Kim, "Design of reconfigurable antenna feeding network using coupled-line switch for 5G millimeter-wave communication system," *Appl. Comput. Electromagn. Soc. J.*, vol. 33, no. 8, pp. 861-867, Aug. 2018.
- [4] A. Podell, "A high directivity microstrip coupler technique," *IEEE G-MTT 1970 Int. Microwave Symp.*, Newport Beach, CA, pp. 33-36, May 1970.
- [5] D. D. Paolino, "MIC overlay coupler design using spectral domain technique," *IEEE Trans. Microw. Theory Tech.*, vol. 26, no. 9, pp. 646-649, Sep. 1978.
- [6] B. Sheleg and B. E. Spielman, "Broad-band directional couplers using microstrip with dielectric overlays," *IEEE Trans. Microw. Theory Tech.*, vol. 22, no. 12, pp. 1216-1220, Dec. 1974.
- [7] L. Su, T. Itoh, and J. Rivera, "Design of an overlay directional coupler by a full-wave analysis," *IEEE Trans. Microw. Theory Tech.*, vol. 31, no. 12 pp. 1017-1022, Dec. 1983.
- [8] S. Uysal and H. Aghvami, "Synthesis, design, and construction of ultra-wide-band nonuniform quadrature directional couplers in inhomogeneous media," *IEEE Trans. Microw. Theory Tech.*, vol. 37, no. 6, pp. 969-976, June 1989.
- [9] J. L. Klein and K. Chang, "Optimum dielectric overlay thickness for equal even- and odd-mode phase velocities in coupled microstrip circuits," *Electron. Lett.*, vol. 26, no. 5, pp. 274-276, Mar. 1990.
- [10] S. L. March, "Phase velocity compensation in parallel-coupled microstrip," *1982 IEEE MTT-S Int. Microwave Symp. Dig.*, Dallas, TX, pp. 410-412, June 1982.
- [11] G. Schaller, "Optimization of microstrip directional couplers with lumped capacitors," *AEU-Int. J. Electron. C.*, vol. 31, pp. 301-307, July-Aug. 1977.
- [12] M. Dydyk, "Accurate design of microstrip directional couplers with capacitive compensation," *IEEE Int. Dig. on Microwave Symp.*, Dallas, TX,

- pp. 581-584, May 1990.
- [13] D. Kajfez, "Raise coupler directivity with lumped compensation," *Microwaves*, vol. 27, pp. 64-70, Mar. 1978.
 - [14] I. J. Bahl, "Capacitively compensated high performance parallel coupled microstrip filters," *IEEE MTT-S Int. Microwave Symp. Dig.*, Long Beach, CA, pp. 679-682, June 1989.
 - [15] R. Phromloungsri, M. Chongcheawchamnan, and I. D. Robertson, "Inductively compensated parallel-coupled microstrip lines and their applications," *IEEE Trans. Microw. Theory Tech.*, vol. 54, no. 9, pp. 3571-3582, Sep. 2006.
 - [16] R. Phromloungsri, V. Chamnanphrai, and M. Chongcheawchamnan, "Design high-directivity parallel-coupled lines using quadrupled inductive-compensated technique," *2006 Asia-Pacific Microwave Conference*, Yokohama, Japan, pp. 1380-1383, Dec. 2006.
 - [17] S. Lee and Y. Lee, "An inductor-loaded microstrip directional coupler for directivity enhancement," *IEEE Microw. Wirel. Compon. Lett.*, vol. 19, no. 6, pp. 362-364, June 2009.
 - [18] S. Lee and Y. Lee, "A design method for microstrip directional couplers loaded with shunt inductors for directivity enhancement," *IEEE Trans. Microw. Theory Tech.*, vol. 58, no. 4, pp. 994-1002, Apr. 2010.
 - [19] J. Ha, W. Shin, and Y. Lee, "An inductive-loading method for directivity enhancement of microstrip coupled-line couplers," *IEEE Microw. Wirel. Compon. Lett.*, vol. 27, no. 4, pp. 356-358, Apr. 2017.
 - [20] H. M. Liu, S. J. Fang, Z. B. Wang, and Y. Zhou, "Miniaturization of trans-directional coupled line couplers using series inductors," *Prog. Electromagn. Res. C.*, vol. 46, pp. 171-177, Jan. 2014.
 - [21] D. M. Pozar, *Microwave Engineering*, 4th Edition, Wiley, New York, Nov. 2011.
 - [22] Sonnet Lite, ver. 13.51, Sonnet Software, Syracuse, NY, 2019.



Somchat Sonasang was born in Nong Bua Lam Phu Province, Thailand on October, 27, 1982. He received a B.Eng. from Rajamangala University of Technology Isan (RMUTI), Nakhon Ratchasima, Thailand in 2006, and an M.Eng. from Khon Kaen University (KKU), Khon Kaen, Thailand in 2013. He is currently working towards a Ph.D. at Mahasarakham University (MSU), Maha Sarakham, Thailand. His current research interests include microwave circuits and non-destructive tests.



Niwat Angkawisitpan was born in Khon Kaen, Thailand. He received his B.Eng. in Electrical Engineering with honors from Khon Kaen University, Thailand in 1997. He received his M.Sc. in Electrical & Computer Engineering from Purdue University, Indiana, USA in 2003. He received his Ph.D. in Electrical Engineering from University of Massachusetts Lowell, Massachusetts, USA in 2009. Since 2009, he has been with the Research Unit for Computational Electromagnetics and Optical Systems (CEMOS), Faculty of Engineering, Mahasarakham University, Maha Sarakham, Thailand as a Lecturer. He has authored or co-authored several papers in scientific journals and conference proceedings. His research interests include compact microstrip devices, meta-material applications for RF and microwave circuits, and electromagnetic material characterization.