

# Design of Millimeter Wave Radar Antenna Array with Flat-top Pattern

Nan Wang<sup>1</sup>, Yibo Zhang<sup>2</sup>, Kun Gao<sup>3</sup>, Jian Wu<sup>4</sup>, Beijia Dang<sup>4</sup>, Zhizhan Kong<sup>2</sup>,  
Haokun Wei<sup>1</sup>, Feng Gao<sup>1</sup>, and Shuangyang Liu<sup>5</sup>

<sup>1</sup>Power Research Institute of State Grid Shaanxi Electric Power Corporation Limited  
Xi'an, 710000, China  
232960917@qq.com, haokun.wei@foxmail.com, 15291830460@163.com

<sup>2</sup>State Grid Shaanxi Electric Power Corporation Limited  
Xi'an, 710000, China  
zhangyibo7373@163.com, kongzhizhan@126.com

<sup>3</sup>State Grid Xi'an Electric Power Corporation  
Xi'an, 710000, China  
Gaokun@sn.xa.sgcc.com.cn

<sup>4</sup>State Grid Shaanxi Power Transmission and Transformation Engineering Co., Ltd.  
Xi'an, 710000, China  
1053914849@qq.com, 172801427@qq.com

<sup>5</sup>School of Information and Communications Engineering  
Xi'an Jiaotong University, Xi'an, 710049, China  
lsy6820@stu.xjtu.edu.cn

**Abstract** – In this paper, a planar millimeter wave radar array antenna with flat-top pattern is proposed for wide detection angle. Firstly, the Chebyshev synthesis method is used to design the linear array with high gain and low sidelobe pattern which works in the 24 GHz frequency band. The maximum gain of the linear array is roughly 15 dBi, and the main-sidelobe ratio is close to 20 dB. By setting the excitations and phases distribution of the planar array feeding network, a  $5 \times 4$  antenna array with a flat-top pattern is obtained. The simulated and measured results show that the radar antenna array has a wide half-power beamwidth of 88 degrees, which can ensure that the automotive radar has a longer detection range and a larger monitoring angle.

**Index Terms** – Chebyshev synthesis method, flat-top pattern, low sidelobe, millimeter wave radar antenna.

## I. INTRODUCTION

Millimeter wave radar array antennas play an important role in unmanned driving and automobile collision avoidance radar systems due to their short wavelength, low sidelobe, high gain and other advantages. The 24 GHz vehicle-mounted radar can be used to detect obstacles around the vehicle and the driving environment

in front. In order to meet the needs of speed, distance and angle measurement, the vehicle-mounted radar has certain requirements for the designed antenna. Firstly, the antenna needs to have higher gain in order to obtain a greater detection distance. Secondly, the antenna needs to have a suitable beamwidth in order to avoid interference from vehicles in other lanes, and at the same time, the antenna also needs to meet the characteristics of low sidelobes [1, 2].

The design of antenna array is one of the main methods to improve the performance of the antenna [3, 4]. For instance, we can use optimization algorithms to design a shaped radiation pattern of the antenna array according to a specific application scenario [5–7], which quickly can save time and effort. Different array synthesis methods can also be used to achieve the goal [1, 8–10]. For example, antenna arrays with a sector beam pattern are designed on the premise of maintaining controllable excitation amplitude and phase according to the Woodward-Lawson array synthesis method [8]. The Taylor synthesis method [9] and the Chebyshev synthesis method [1, 10] are used to design antenna arrays with low sidelobes and high gain patterns. C. Wang, Y. Chen and S. Yang propose a planar antenna array with flat-top and sharp cut-off radiation patterns and the half-power beamwidth (HPBW) of the array in both the H-plane and

E-plane exceeds  $45^\circ$ , but its gain is low [11]. R. Chopra and G. Kumar design a  $9 \times 9$  high-gain planar antenna array by using two different feeding methods at the linear arrays' edges of the E-plane and H-plane, which are U-series and angular feeding, respectively [12]. The cross-polarization of the array is low, but its beamwidth is narrow. The performance of these antennas cannot meet the application requirements of millimeter wave automotive radar antennas perfectly.

In this paper, a millimeter wave radar antenna array with high gain, low sidelobe and wide beam is designed according to the application requirements of 24 GHz vehicle radars. The antenna array structures are designed and described in Section II, and the simulated and measured results are shown in Section III. Finally, the conclusion is given at the last section.

## II. ANTENNA DESIGN

### A. Design of series-fed antenna

The microstrip patch antenna is a commonly used radar antenna structure, which has the advantages of efficient processing, small size, and a flexible structure. However, the gain of a single microstrip antenna is relatively low, only 6 dBi-8 dBi [1, 2]. Therefore, we arrange the single microstrip antennas in a certain way to form a five-element series-fed linear array, and use MATLAB to obtain the current amplitude when  $N = 5$  and sidelobe level (SLL) = 20 dB according to the Chebyshev synthesis method. The current amplitude is shown in Table 1.

The center frequency  $f_0$  of the series-fed antenna designed in this paper is 24 GHz, and we use Rogers 5880 dielectric substrate with a dielectric constant of 2.2, a loss tangent of 0.0009, and a thickness of 0.508 mm, which is one of the commonly used radio frequency and microwave circuit boards, with high coverage frequency and low loss. Since the current amplitude value is related to the impedance of the patch, and the impedance changes with the change of the patch size, we can change the current amplitude value by adjusting the size of the patch to make it meet our expectations. As adjacent patches are coupled with each other and then change the amplitude and phase of each other's currents, it is necessary to optimize the parameters by using the simulation software HFSS to determine the optimal size of each patch. In addition, as the width of the patch changes, the length of the feeder connecting the microstrip patch also needs to be optimized to ensure that the distance between adjacent patches is approximately  $\lambda_g$  ( $\lambda_g$  is the guided wavelength at  $f_0$ ), so that the array elements are in phase to achieve edge-fire characteristics.

The model of the series-fed linear array is shown in Fig. 1. The main feeder of the antenna (0.5 mm line width) and the 50-ohm port feeder (1.5 mm line width)

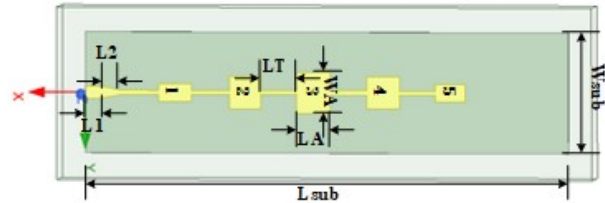

Fig. 1. The structure of the series-fed five-element patch linear array.

Table 1: Current amplitude coefficient calculated by Chebyshev synthesis method

Element Number	Coefficient Lowercase	Normalized Coefficient
1	1	0.5176
2	1.6085	0.8326
3	1.9319	1
4	1.6085	0.8326
5	1	0.5176

Table 2: Values of the patches parameters

Patch Number	WA(mm)	LA(mm)	LT(mm)
1	2.2	4.1	4.6
2	4.1	3.9	4.7
3	5.1	4.1	4.5
4	4	4	4.6
5	2.2	3.7	4.5

are transitioned using a gradual structure to achieve good impedance matching, where  $L1 = 2$  mm,  $L2 = 2.5$  mm, and other optimized parameter values are shown in Table 2.

### B. Design of the planar array antenna

Based on the series-fed linear array designed by the Chebyshev synthesis method, we designed a millimeter wave radar antenna array with a wider beam to identify and track multiple targets at the same time. A  $5 \times 4$  area array is simulated and the model structure and physical figure are shown in Figs. 2 and 3, respectively.  $D=6.25$  mm, which is  $0.5\lambda_0$  ( $\lambda_0$  is the free space wavelength at  $f_0$ ). Furthermore, by using a deep learning parameter optimization algorithm, the excitations and phases distribution of the feeding network when  $N = 4$ , HPBW  $>80^\circ$  are obtained quickly, as shown in Table 3. The feeding network is composed of cascaded multi-level T-type networks, the first-level T-type power distribution network is an equal power distribution network, and the one-to-four power distribution feeding network realizes the power distribution ratio and phase

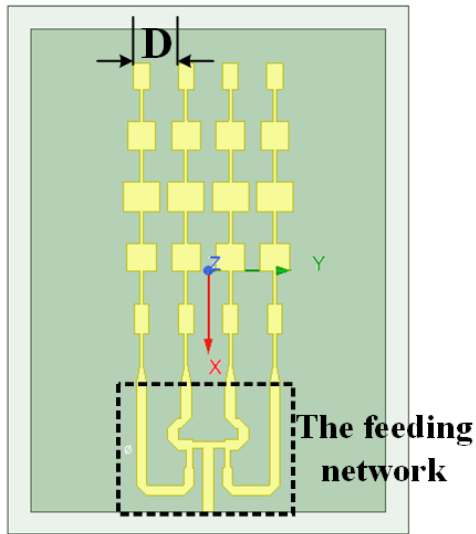

Fig. 2. The structure of the 5×4 planar array antenna.

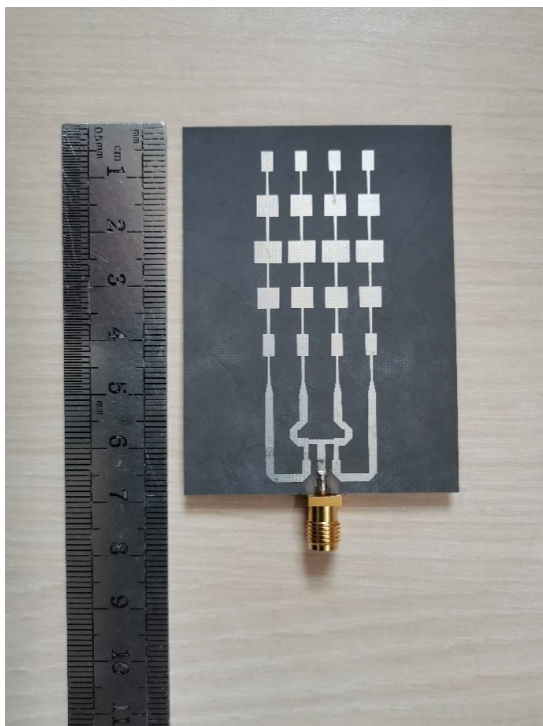

Fig. 3. The fabricated planar array antenna photograph.

difference that meet the requirements of the flat-top pattern. The simulated results are shown in Figs. 4 and 5, respectively.

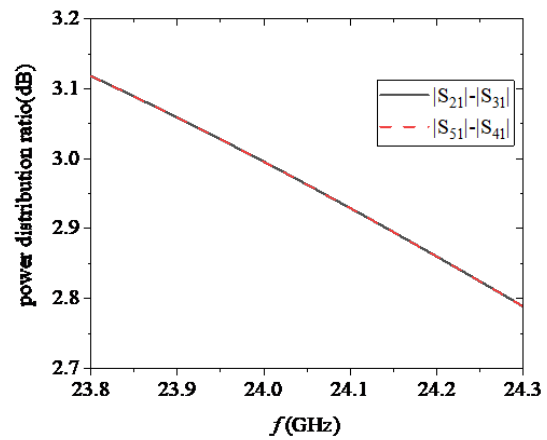

Fig. 4. The simulated power distribution ratio of the feeding network.

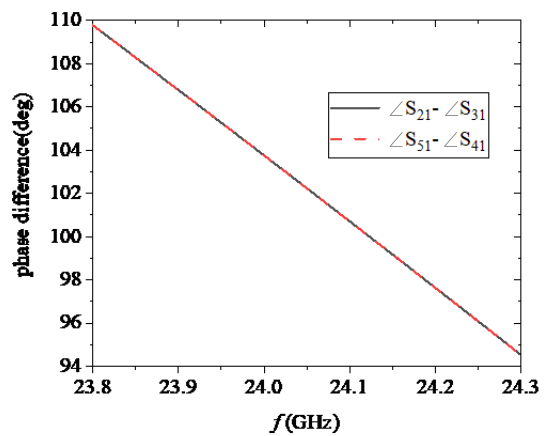

Fig. 5. The simulated phase difference of the feeding network.

Table 3: Distributions of excitations and phases

Port Number	Optimized Excitations	Excitations of Feeding Network
1	$1\angle 0$	$1\angle 0$
2	$2\angle -102$	$1.99\angle -103.78$
3	$2\angle -102$	$1.99\angle -103.78$
4	$1\angle 0$	$1\angle 0$

### III. RESULTS

#### A. Results of series-fed antenna

The simulated reflection coefficients and radiation patterns results of the series-fed linear array are shown in Figs. 6 and 7, respectively. Its working bandwidth is 23.983-24.36 GHz, so the absolute bandwidth is

0.377 GHz, and the relative bandwidth is 1.57%. The maximum gain of the E-plane pattern is about 15 dBi, and the SLL is nearly 20 dB. The microstrip antenna unit forms a series-fed array only in the X direction. Therefore, compared with the patterns of a single rectangular microstrip patch antenna [1, 2], the SLL and beamwidth of the E-plane (XOZ plane) are significantly reduced, while the SLL and beam width of the H plane pattern (YOZ plane) are almost unchanged.

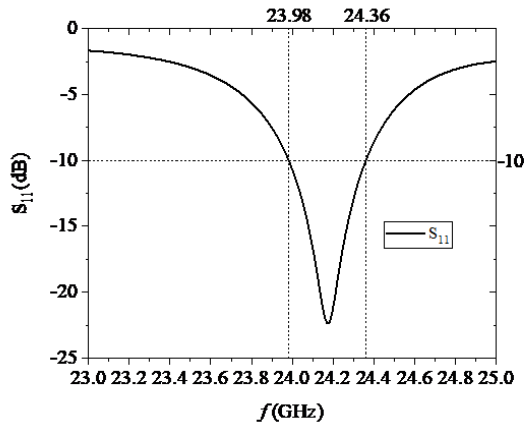

Fig. 6. The simulated reflection coefficients of the series-fed five-element patch linear array.

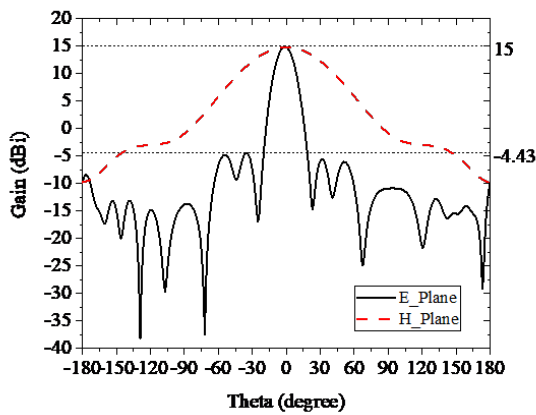

Fig. 7. The simulated radiation patterns of the series-fed five-element patch linear array.

**B. Results of the planar array antenna**

Figure 8 shows the simulated and measured S-parameters of the radar antenna array. Its bandwidth covers the working frequency band of a 24 GHz vehicle radar (24-24.25 GHz), and the return loss is greater

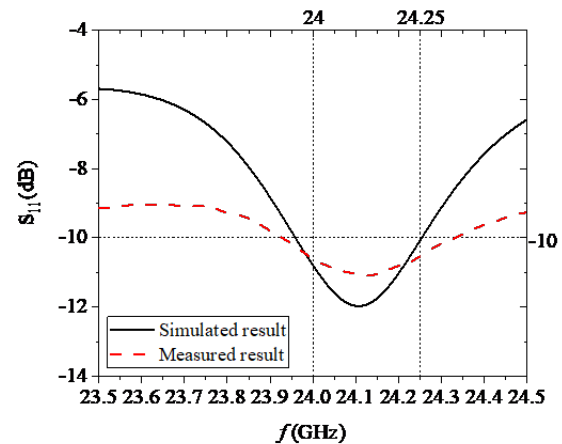

Fig. 8. The simulated and measured reflection coefficients of the planar array antenna.

than 10 dB within the required bandwidth. The anechoic chamber can be used to test the antenna patterns in the low frequency band [13]. In this paper, the near-field anechoic chamber test method is used to test them. The comparison between the simulated and measured radiation patterns are shown in Figs. 9 and 10. The maximum gain is roughly 12.7 dBi, and the SLL of the E-plane pattern is close to 13 dB. Furthermore, the HPBW of the H-plane is approximately 88 degrees, the SLL is greater than 17 dB, the average gain is about 12.3 dBi, and the fluctuation range is less than  $\pm 0.5$  dB in the beam range from  $-25^\circ$  to  $+25^\circ$ . Compared with the uniformly excited array, the antenna array has a lower maximum gain, which is a compromise between the gain and beamwidth [14]. There are some errors between all the

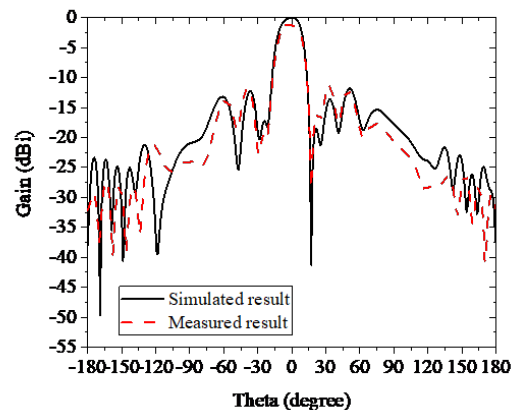

Fig. 9. The simulated and measured E-plane of the planar array antenna.

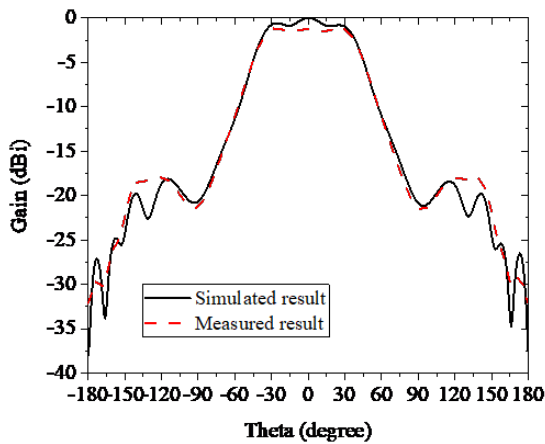

Fig. 10. The simulated and measured H-plane of the planar array antenna.

measured and simulated results, which may be caused by the actual plate loss and machining accuracy, but the trend of the two is the same, and the measured results are fundamentally consistent with the simulation results.

#### IV. CONCLUSION

In this paper, a millimeter wave radar antenna array with the flat-top pattern is designed for the application requirements of 24 GHz vehicle radars. The Chebyshev synthesis method is used to design the series-fed linear array, and the appropriate excitation and phase distribution of the array elements are obtained by using a deep learning parameter optimization algorithm. The radar antenna array bandwidth covers the working frequency (24-24.25 GHz) band of a 24 GHz vehicle radar, the maximum gain is roughly 12.7 dBi, and the SLL of the E-plane pattern is nearly 13 dB. The HPBW of the H-plane is approximately 88 degrees, and the average gain is about 12.3 dBi and the fluctuation range is less than  $\pm 0.5$  dB in the beam range of  $-25^\circ$  to  $+25^\circ$ , and the SLL is greater than 17 dB. In summary, the radar antenna array has high gain, appropriate lobe width, and at the same time satisfies the characteristics of low side-lobes, so it has a good performance.

#### ACKNOWLEDGMENT

This work was supported by the project of State Grid Shaanxi Electric Power Company Limited under Grant No. 5226SX21002Q.

#### REFERENCES

- [1] Y. Zhang, Y. Chen, Y. Liu, and Y. Lu, "Millimeter wave microstrip antenna array for automotive collision avoidance radar," *Int. Appl. Computat. Electromagn. Soc. Symp. - China (ACES)*, Beijing, pp. 1-2, Jul. 2018.
- [2] Y. Chen, Y. Liu, Y. Zhang, Z. Yue, and Y. Jia, "A 24 GHz millimeter wave microstrip antenna array for automotive radar," *Int. Symp. Antenn. and Propag. (ISAP)*, Xi'an, pp. 1-2, Oct. 2019.
- [3] X. Chen, M. Zhao, H. Huang, Y. Wang, S. Zhu, C. Zhang, J. Yi, and A. A. Kishk, "Simultaneous decoupling and decorrelation scheme of MIMO arrays," *IEEE Trans. Vehicular Technol.*, vol. 71, no. 2, pp. 2164-2169, 2022.
- [4] Y. Wang, X. Chen, X. Liu, J. Yi, J. Chen, A. Zhang, and A. A. Kishk, "Improvement of diversity and capacity of MIMO system using scatterer array," *IEEE Trans. Antenn. and Propag.*, vol. 70, no. 1, pp. 789-794, 2022.
- [5] G. K. Mahanti, T. K. Sinhamahapatra, A. Ahmed, and A. Chakrabarty, "Synthesis of flat-top beam pattern with a multiple concentric circular ring array antenna," *IEEE Region 10 and 3rd Int. Conf. Ind. and Inf. Sys.*, Kharagpur, pp. 1-4, Dec. 2008.
- [6] J. Jiping, Z. Youling, and B. Yong, "An improved array pattern synthesis algorithm based on Chebyshev polynomial," *Proc. 2011 Int. Conf. Comput. Sci. and Netw. Technol.*, Harbin, pp. 1125-1127, Dec. 2011.
- [7] J. K. Modi, K. K. Suman, R. K. Gangwar, and V. S. Gangwar, "Investigation on realistic synthesis approach for shaped beam patterns and its validation through EM simulation study," *IEEE Int. Conf. Electron., Comput. and Commun. Technol. (CONECCT)*, Bangalore, pp. 1-4, Jul. 2020.
- [8] A. M. Maruti and B. S. N. Kishore, "High gain and wide bandwidth array antenna for sector beam pattern synthesis," *Prog. Electromagn. Res. Lett.*, vol. 100, pp. 109-116, 2021.
- [9] L. A. R. Solano, M. S. Perez, and D. P. Santos, "Design, simulation and test of a slot antenna array using one parameter Taylor synthesis in the GHz range," *IEEE Latin America Trans.*, vol. 13, no. 10, pp. 3210-3215, 2015.
- [10] F. Enache, D. Deperateanu, A. Enache, and F. Popescu, "Sparse array antenna design based on dolph-chebyshev and genetic algorithms," *8th Int. Conf. Electron., Comput. Artific. Intell. (ECAI)*, Ploiesti, pp. 1-4, Jul. 2016.
- [11] C. Wang, Y. Chen, and S. Yang, "Dual-band dual-polarized antenna array with flat-top and sharp cutoff radiation patterns for 2G/3G/LTE cellular bands," *IEEE Trans. Antenn. and Propag.* vol. 66, no. 11, pp. 5907-5917, 2018.
- [12] R. Chopra and G. Kumar, "Series- and corner-fed planar microstrip antenna arrays," *IEEE Trans.*

*Antenn. and Propag.*, vol. 67, no. 9, pp. 5982-5990, 2019.

- [13] W. Xue, Y. Ren, X. Chen, Z. Wang, Y. Li, and Y. Huang, "Measurement uncertainty of antenna efficiency measured using the two-antenna method in a reverberation chamber," *Applied Computational Electromagnetics Society (ACES) Journal*, vol. 36, no. 9, pp. 1152-1158, Sep. 2021.
- [14] X. Cai, W. Geyi, and Y. Guo, "A compact rectenna with flat-top angular coverage for RF energy harvesting," *IEEE Antenn. and Wirel. Propag. Lett.*, vol. 20, no. 7, pp. 1307-1311, Jul. 2021.



**Nan Wang** received his MSc degree in electromagnetic and microwave technology from Xidian University, Xi'an, China, in 2010. His current research interests include the research of operation and maintenance technology of power transmission and transformation equipment.



**Yibo Zhang** received his MSc degree in power electronics and power transmission from Xi'an University of Technology, Xi'an, China, in 2012. His current research interests include equipment technical maintenance and safety supervision.



**Kun Gao** received his MSc degree in electrical engineering and automation from North China Electric Power University, Beijing, China, in 2008. His current research interests include the operation and maintenance management of power transmission and transformation equipment.



**Jian Wu** received his BSc degree in electrical engineering and automation from Xi'an Polytechnic University, Xi'an, China, in 2020. His current research interests include transmission line construction management.



**Beijia Dang** graduated from Xi'an Electric Power College, Xi'an, China, in 2019 and majoring in electrical engineering and automation. Her current research interests include power grid emergency management.



**Zhizhan Kong** received the BSc degree in electrical engineering and automation from Shaanxi University of Technology, Hanzhong, China, in 1989. His current research interests include the operation and maintenance management of power transmission and transformation equipment.



**Haokun Wei** received his Ph.D. degree in electrical engineering from Xi'an University of Technology, Xi'an, China, in 2020. His current research interests include the power system, new energy consumption and other aspects.



**Feng Gao** received his MSc degree in electrical engineering and automation from Xi'an Jiaotong University, Xi'an, China, in 2010. His current research interests include the research of operation and maintenance technology of power transmission and transformation equipment.



**Shuangyang Liu** received the BSc degree in Information Engineering from Xi'an Jiaotong University, Xi'an, China, in 2020. She is currently pursuing an MSc degree in electronic information at Xi'an Jiaotong University. Her current research interests include metamaterials and antennas.