

A Hybrid Framework for Antenna/Platform Analysis

(Invited Paper)

**R. J. Burkholder, P. H. Pathak, K. Sertel,
R. J. Marhefka, and J. L. Volakis**

The Ohio State University Dept. of Electrical and Computer Eng.
ElectroScience Lab, 1320 Kinnear Road, Columbus, OH 43212

R. W. Kindt

Naval Research Laboratories, Radar Division
4555 Overlook Ave. SW, Washington, D.C. 20375

Abstract— Hybrid combinations of numerical and asymptotic methods are utilized to evaluate in-situ antenna performance, and coupling to other systems on a shared platform such as a ship topside. This paper describes a combination of the finite element-boundary (FE-BI) method with ray techniques for evaluating antenna patterns in the presence of complex platforms. Specifically, a very complex array antenna may be modeled with FE-BI, and interfaced to the platform via the use of equivalent currents. For the case considered here, the FE-BI is accelerated with the array decomposition fast multipole method (AD-FMM) so that large arrays may be considered. A novel discrete Fourier transform method is also introduced to provide a greatly reduced representation of the fields over a planar array aperture and the uniform theory of diffraction (UTD) along with iterative physical optics (IPO) are used to characterize the platform. To tie it all together, a matrix framework is formulated to iteratively increment the higher order interactions between antennas and platform.

I. INTRODUCTION

The Ohio State University ElectroScience Laboratory (OSU-ESL) has a long history of studying the performance of antennas mounted on realistic platforms [1,2]. Prior to using numerical methods, these studies were carried out experimentally, and later also by using ray methods such as the uniform geometrical theory of diffraction (UTD) [3]. Today's availability of numerical methods and their success to accurately

model conformal antennas present us with new hybrid tools [4] for modeling realistic antenna structures (and not just simple sources) on complex platforms.

In this article we introduce hybrid techniques for the analysis of electromagnetic (EM) radiation from, and the coupling among, large multiple antenna arrays mounted on a large complex platform, such as a ship (see Figure 1). Other large platforms may include airborne and land vehicles. The antenna-platform problem is challenging because numerical methods require very large computational resources even for the array itself. This is compounded by the presence of the platform and the necessity to account for interactions among multiple antennas. The hybrid approach combining numerical methods for large antenna arrays and high frequency methods for dealing with large platforms appears to be well suited to solve such practical problems in a tractable manner.

In our analysis, the FE-BI along with domain decomposition approach, is used for array analysis [4], whereas the platform is accounted for via high frequency asymptotic methods (see Figure 1). The UTD method [3] is used to model the whole ship at very high frequencies via the UTD-based NEC-Basic Scattering Code (NEC-BSC) [5], which has been extensively used for ship modeling. There are several features of NEC-BSC that make it attractive. Among them are the capability to find ray paths for ship structures efficiently and its CPU scalability as the size increases. In fact, UTD becomes more accurate as the frequency increases. For more arbitrarily shaped CAD models the

iterative physical optics (IPO) method can be more appropriate than NEC-BSC since it can deal with situations for which UTD diffraction coefficients

are not currently available [6,7]. IPO has been shown to give good accuracy, and is considerably more efficient than pure numerical

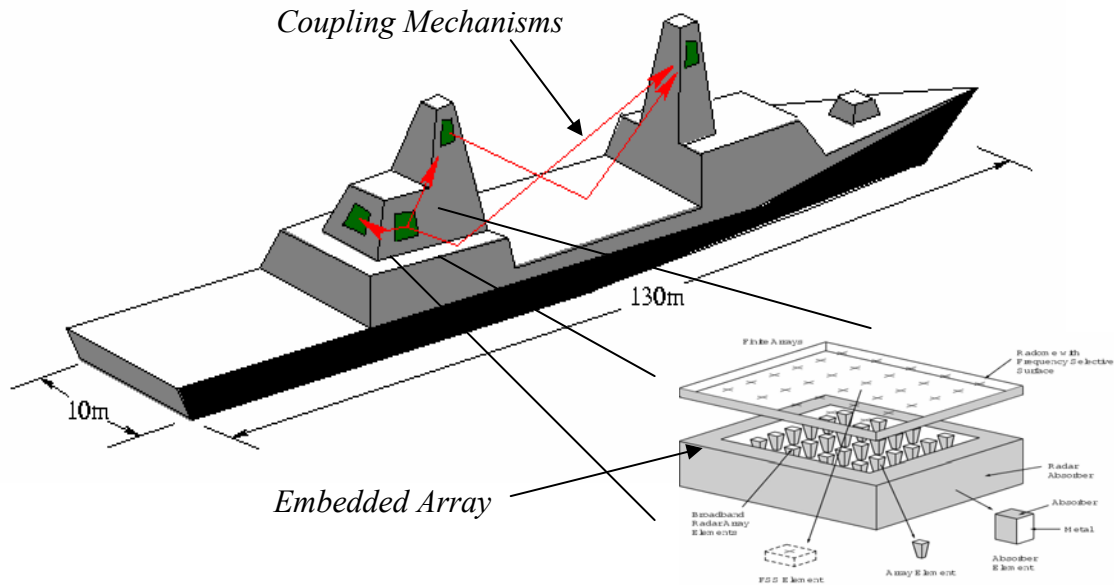

Figure 1: Interactions between antenna arrays on a modern naval vessel.

methods. As such, the IPO serves to bridge the gap between the numerical and the UTD-based approaches.

Central to the proposed hybrid approach is the means of representing the fields over the array apertures in a reduced basis set. This is necessary to efficiently handle the antenna-platform interactions. For this purpose, a novel approach is proposed using a discrete Fourier transform (DFT) representation of the aperture fields which is subsequently truncated to extract the reduced basis set [8]. A more recent approach is to employ a traveling wave (TW) basis set [9] which is even more efficient than the DFT; the latter approach will not be discussed here, but it will be described in detail in a future publication.

The format of this paper is as follows: Section II describes the general formulation for hybridizing the FE-BI method with the high-frequency approaches. Section III gives a brief summary of the accelerated FE-BI method used for analyzing finite array antennas [4], and Section IV describes how high-frequency methods are employed for platform interactions. The integration of the FE-BI method for antennas and the high frequency methods for the platform along

with the reduced basis set expansion are described in Section V. Several validation examples are given throughout.

II. GENERAL APPROACH TO HYBRIDIZATION

The main idea of the proposed hybridization approach is to decompose the structure into different domains. These domains are subsequently coupled by iteratively accounting for multiple interactions. Such interactions can be either among array apertures or between an aperture and the array platform ship structure. It is understood that each individual array aperture must be analyzed with rigorous methods. In this case the FE-BI method enhanced with domain decomposition and fast algorithms will be used [4]. Certainly, other analysis methods can be used as they are available.

Let us assume that one of the antennas or substructures can be characterized by a matrix $[Z]$. This matrix can be generated via the method of moments, the finite element method or the FE-BI method. For the latter,

$$[Z] = \begin{bmatrix} E_{vv} & E_{vs} & 0 \\ E_{sv} & E_{ss} & B \\ 0 & P & Q \end{bmatrix} \quad (1)$$

in which E_{vv} , E_{vs} , E_{sv} , E_{ss} , B , P , and Q denote sub-matrices. More specifically, P and Q in (1) are full matrices resulting from the integral operators used to express the fields external to the solution domain, and the remaining sub-matrices are the usual sparse FE matrices for surface and volume unknowns [4].

Regardless of the method used for characterizing a single component of the structure, let us denote the associated matrices for multiple components as $[Z_{11}]$, $[Z_{22}]$, etc. The complete coupling matrix that includes all interactions between the #1 and #2 components or arrays would then be [10],

$$[Z]_{coupled} = \begin{bmatrix} Z_{11} & Z_{12} \\ Z_{21} & Z_{22} \end{bmatrix} \quad (2)$$

where Z_{ij} account for cross-coupling interactions. When Z_{ii} is generated via FE-BI, the coupling matrices have the form,

$$Z_{ij}|_{i \neq j} = \begin{bmatrix} 0 & 0 & 0 \\ 0 & 0 & 0 \\ 0 & P & Q \end{bmatrix} \quad (3)$$

because only the P and Q sub-matrices are needed to “communicate” with outside components.

The identification of (2) allows us to consider matrix partitions and therefore decompose the domain into smaller and more manageable components. Mathematically, we proceed to cast the iterative solution of $[Z]_{complex} \{x\} = \{b\}$ as,

$$\begin{bmatrix} Z_{11} & 0 \\ 0 & Z_{22} \end{bmatrix} \begin{Bmatrix} x_1 \\ x_2 \end{Bmatrix}_{(i+1)} = \begin{Bmatrix} b_1 \\ b_2 \end{Bmatrix} - \begin{bmatrix} 0 & Z_{12} \\ Z_{21} & 0 \end{bmatrix} \begin{Bmatrix} x_1 \\ x_2 \end{Bmatrix}_{(i)}. \quad (4)$$

In this set-up $\{x\} = \{x_1, x_2\}^T$ denotes the unknown quantity in domains #1 and #2, respectively, whereas $\{b\} = \{b_1, b_2\}^T$ is the corresponding excitation vector. Setting $\{x\}_{(0)} = \{0, 0\}^T$, (4) can be solved iteratively by updating $\{x\}$ with $\{x\}_{(1)}$,

$\{x\}_{(2)}$, etc., until convergence is achieved to within a prescribed error. The above is known as the Jacobi decomposition approach and allows us to initially solve each component/domain independent of the others and therefore avoid large matrices. Moreover, it allows for each domain to be treated with different methods. As an example, the antenna domain can be treated with a rigorous method, whereas the large ship structure can be handled via high-frequency techniques.

Of particular interest is the number of iterations needed for convergence of (4) since the antenna is conformal to the structure. To observe this, we consider the case of a double stacked circular patch mounted on a thick metallic plate as shown in Figure 2. The plate dimensions are $1\lambda \times 1\lambda \times 0.1\lambda$ and was modeled via the MLFMM [11,12]. For the double stacked patch the FE-BI was used in conjunction with the iterative algorithm (4) to account for coupling among the plate and the antenna.

The iterative solution process is broken into four major steps. First, the antenna itself is solved in isolation via the FE-BI solver with the metallic plate (platform) absent. In the second step the antenna surface currents are radiated onto the nearby structure. The MLFMM (third step) is then used to compute the scattered fields and surface currents induced on the plate by the antenna. Re-radiating these currents back onto the antenna is the fourth step. The steps begin once again using the updated antenna currents in the FE-BI solver. This process continues to be repeated through several iterations until convergence of the antenna and platform currents is achieved to a given level of accuracy.

To validate the proposed iteration scheme, we first computed the antenna input impedance via a direct FE-BI solution that modeled the entire structure as a single antenna. The resulting value was found to be $89.6724 + 32.6572i$ shown by the horizontal lines in Figure 3. Next, we proceeded with the decomposition and iteration. After 20 iterations the input impedance converges to $89.9056 + 32.9705i$. The convergence of the input impedance is shown in Figure 3 as a function of iteration number. The effect of the platform on the input impedance can be seen by the difference between the first iteration and the converged result.

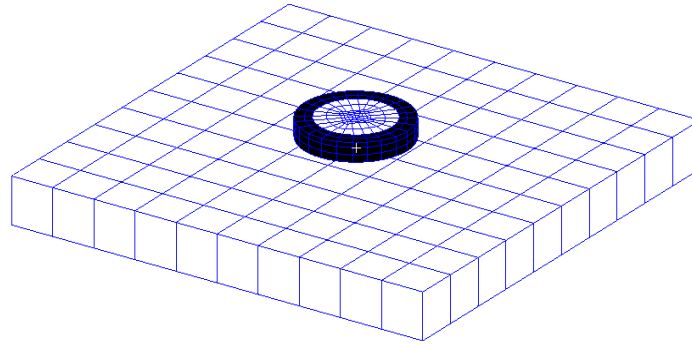

Figure 2: Probe-fed circular stacked patch antenna over a PEC platform. Platform dimensions are $1\lambda \times 1\lambda \times 0.1\lambda$.

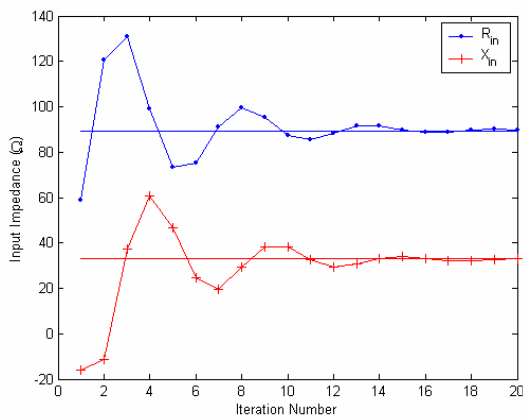
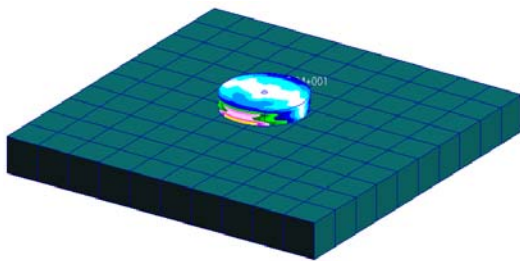
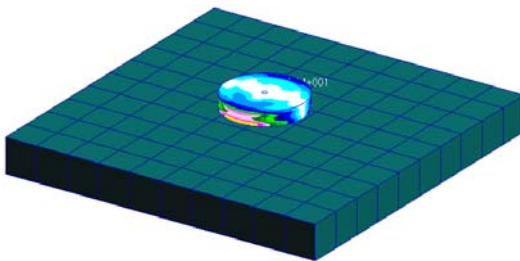

Figure 3: Iterative convergence of the input impedance.

The difference between converged solutions for the antenna and the platform can also be observed in the following figures. Figures 4 (a) and (b) show the fields within the patch antenna. As seen, the converged results are almost identical to the full FE-BI solution. The surface currents induced on the platform are given in Figure 5. They also agree well with the full FE-BI solution. Excellent agreement between the full and iterative methods is demonstrated in Figure 6 for the radiation pattern of the antenna on the platform.



(a) Full FE-BI solution.



(b) Iterative solution.

Figure 4: Electric fields within the patch antenna.

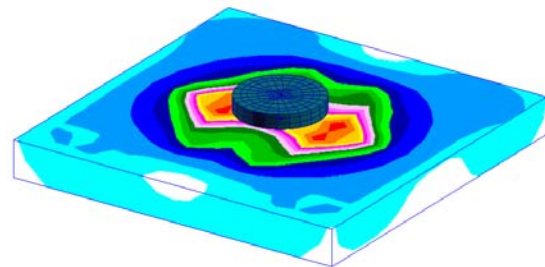

(a) Full FE-BI solution.

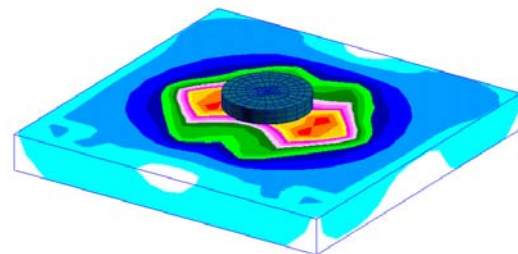

(b) Iterative solution.

Figure 5: Induced surface electric currents on the platform.

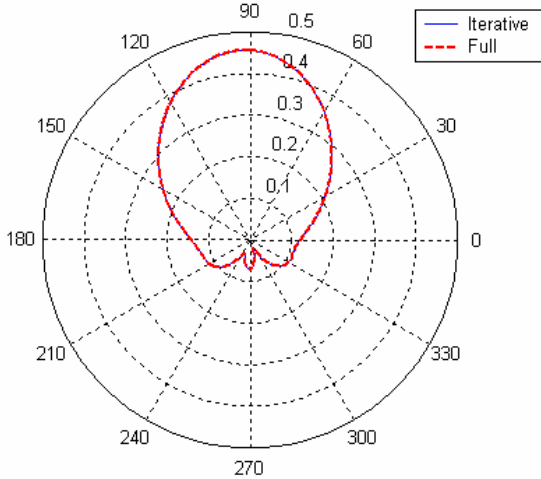

Figure 6: In-situ radiation pattern of the patch antenna.

III. RIGOROUS ANALYSIS OF ANTENNA ARRAYS USING FE-BI

This section summarizes the finite element-boundary integral (FE-BI) method for the rigorous analysis of antenna array structures. It can generate a numerical solution for an antenna array on a complex platform, provided the available computational resources can handle the composite problem (for example, the circular patch antenna on a metallic plate as in Section 2). For larger platforms the FE-BI method may be used in the hybrid scheme described in the last section, wherein the FE-BI method generates the antenna solutions characterized by the matrices Z_{ii} in (2) and (4).

The FE-BI method is useful for modeling complex structures for which an approximate or analytical representation of the structure's electromagnetic properties is not attainable. As expected, FE-BI is able to handle nearly any combination of material properties and arbitrary geometric shapes, making it an ideal tool to analyze complicated antenna structures [13]. However, rigorous analysis tools have practical limits as well. FE-BI and integral equation methods can consume vast amounts of computational resources for electrically large problems. Rather than resort to approximate methods that may not be accurate enough, it is often necessary to introduce special algorithms

that alleviate the computational burden of rigorous methods such as FE-BI. Here we examine a powerful decomposition approach that exploits translational symmetry of the array environment, thereby allowing the use of FE-BI for rigorous analysis of array structures without prohibitive storage requirements. This version of FE-BI, known as the Array Decomposition-Fast Multipole Method (AD-FMM), was most recently considered in [14]. It is briefly described here.

Consider a linear array of n identical antenna elements on a regular grid. Each array element is enclosed in an identical rectangular box. A finite element expansion is used for the fields within the box, and a boundary integral is used on the surface to couple the element to other elements and to the external region. Each boundary integral is discretized using m unique current coefficients. The complete impedance matrix $[Z]$ for the array system is of size $N=(mn)^2$, consisting of n^2 blocks of size m^2 . (A finite element matrix describes the interactions within each box, but this matrix is generally much smaller than the boundary integral matrices, and is the same matrix for all the array elements.) In an array of identical elements, with a fixed spacing between elements (and hence translational symmetry), this system will have a block-Toeplitz property, i.e., the matrix block Z_{pq} is the same as Z_{p-q} . Hence, of the original $(mn)^2$ terms in the $[Z]$ matrix, it is only necessary to store $m^2(2n-1)$ of them without loss of information. The reduced storage format of the impedance matrix takes the form

$$[Z]_{\text{Toeplitz}} = \{Z_{1-n} \ Z_{2-n} \ \cdots \ Z_{-1} \ Z_0 \ Z_1 \ \cdots \ Z_{n-2} \ Z_{n-1}\}. \quad (5)$$

This block-Toeplitz property is the first major component of the AD-FMM algorithm, and it generates a pronounced reduction in storage. In fact, we may stop here and employ the fast Fourier transform (FFT) in the iterative solution of the system matrix as done in [4]. However, we can achieve an even greater reduction in the storage as described next.

The fast multipole method (FMM) is used to factorize the non-adjacent block matrices in (5). If $|p-q| > 1$, the pq th block may be written in the factorized form,

$$Z_{p-q} \approx UT_{p-q}V \quad (6)$$

where V is the “disaggregation matrix,” T_{p-q} is the “translation matrix,” and U is the “reaggregation matrix.” V contains the far-field radiation pattern coefficients of each of the boundary integral basis functions for a given array element, computed in k directions on the unit sphere. U contains the testing of each boundary integral basis function with a plane wave incident from each of the k far-field directions. The k plane wave directions are chosen to be the same as the k far-field directions, so the elements of U are actually the complex conjugates of the elements of V (provided that Galarkin testing is used in the boundary integral). The translation matrix T_{p-q} is derived from a multipole expansion of the free space Green’s function [15]. The accuracy of (6) depends on the truncation of the multipole series, which determines the minimum number of far-field directions k .

The utility of the FMM comes from the fact that T_{p-q} is diagonal and is found analytically. In the AD-FMM approach where identical equally spaced array elements are used, T_{p-q} is also Toeplitz. Therefore, only $2n-1$ translation matrices need to be stored, each with k entries. The U and V matrices are of size km , but they are the same for all the identical array elements. We remark that k is typically of the same order as m , so the storage requirement for U and V is of order m^2 . Likewise, the total storage requirement for all T_{p-q} is $m(2n-1)$. Lastly, we must also store the full self matrix Z_0 and the nearest-neighbor matrices Z_{-1} and Z_1 because FMM is only applicable to separated blocks with $|p-q| > 1$. This storage requirement is $3m^2$. Therefore, the total storage requirement for the AD-FMM is of order $m^2 + mn = m^2 + N$. If $N \gg m$ the storage is $O(N)$. Of course, there is also a required storage of $O(N)$ for the unknown vector coefficients.

The above AD-FMM storage requirements extend to arrays that are periodic in two or three dimensions. The method may also be applied to the interaction of multiple array structures sharing common dimensions or periodicity. This approach

to array analysis has been applied numerous times very successfully, with some advanced applications considered in [4,14]. Figure 7 shows a 10 x 40 slot array conformally mounted on a cylindrical platform structure. The table gives the storage requirements and matrix fill times as the size of the problem increases. As seen, the AD-FMM is compared with the array decomposition method (ADM) of [4], and the MLFMM. The AD-FMM matrix storage and fill time does not change as the number of unknowns increases from 15 thousand to nearly 7 million!

IV. INTERACTION WITH PLATFORM

The basis expansion of the aperture fields for each antenna via the boundary integral provides a set of equivalent sources/receivers existing in the presence of the platform structure. The interactions between the sources/receivers of any two antennas are represented by the matrices Z_{12} and Z_{21} in (2) and (4) which incorporate the effects of the platform. Evaluating these interactions amounts to computing the matrix-vector product (MVP) in (4),

$$\text{MVP} = \begin{bmatrix} 0 & Z_{12} \\ Z_{21} & 0 \end{bmatrix} \begin{Bmatrix} x_1 \\ x_2 \end{Bmatrix}. \quad (7)$$

For moderately large platforms, the MVP can be computed with the multi-level fast multipole method (MLFMM) which furnishes an efficient full-wave solution to the integral equation of the platform [11,12]. The MLFMM requires a sampling density on the order of 100 surface basis functions per square wavelength. At 1 GHz this translates to a minimum of about 7 million unknowns required to model the ship’s topside. Therefore, the platform can become prohibitively large for the MLFMM at frequencies above 1 GHz. However, it is still very useful for communication frequencies below 1 GHz and provides reference solutions for validating the more approximate high-frequency asymptotic methods.

- Aircraft fuselage (Cylinder)
- Problem size: 1.5 million unknowns
- 100λ in circumference, 30λ tall
- Conformal 10×40 slot array
- Memory requirement using traditional methods: 25 Terabytes
- ADM memory requirement ~10 Gigabytes – over 3 orders magnitude storage savings

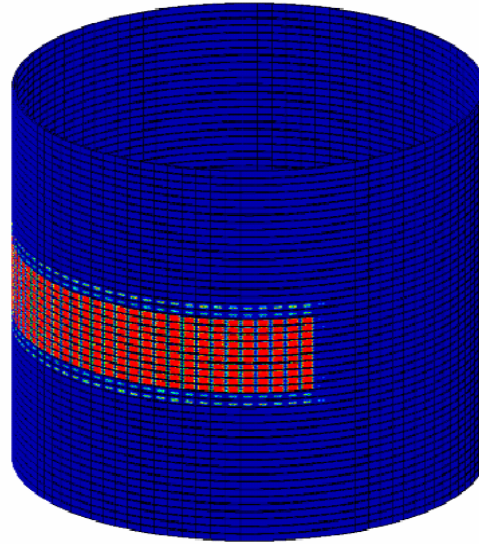

Figure 7: Conformal slot array on a cylinder.

For higher frequencies, the iterative physical optics (IPO) method incorporates high-frequency asymptotic principles to solve the platform integral equation more approximately [7,16]. The IPO refines the first-order PO currents by iterating the magnetic field integral equation (MFIE), thereby including multi bounce and multi-diffraction effects. The brute force numerical evaluation of the MFIE at N test points is an $O(N^2)$ computation, but the numerical sampling density of IPO is only on the order of 4 to 16 points per square wavelength. It also uses a simple shadowing rule to determine if any two points “see” each other. This greatly reduces the number of point-to-point computations [17]. Our IPO analysis has also been accelerated with the fast far-field approximation [18] to further reduce the computational complexity down to $O(N^{3/2})$ as described in [17]. These factors produce a highly efficient code for analyzing electrically large multi-bounce structures with a good degree of accuracy. Furthermore, IPO may be applied directly to CAD geometries because no ray tracing is involved.

Figure 8 displays a validation of the induced currents on a generic ship excited by a vertical dipole mounted above the forward mast. The frequency is 200 MHz and the Ohio State

University (OSU) MLFMM code [12] with 290,000 unknowns was used for reference. (OSU-MLFMM took 4.5 hours to run on a 6 CPU Itanium 2 cluster.) However, the OSU-IPO code required only 60,000 unknowns for the same problem, and took 8 minutes on a Pentium III PC workstation. The induced currents are in good agreement, although the IPO currents do not show as much resolution because of the coarser sampling density. The far-field pattern of the dipole in the presence of the ship is also shown. As seen, the agreement between the full wave result (OSU-MLFMM) and IPO is excellent in the upper half-space.

The advantage of IPO is demonstrated in Figure 9 and shows the induced currents on a DDG-52 cruiser model excited by an 11-by-11 array radiating at 1 GHz. The 11-by-11 array was placed at one of the locations of the SPY-1 phased array. Here, the IPO method required 270,000 unknowns, but ran in a reasonable amount of time on a low-end PC workstation. For comparison, the MLFMM would require around 5 million unknowns and need to be run on a supercomputer. The gain pattern of the array in free space and in presence of the ship is also shown.

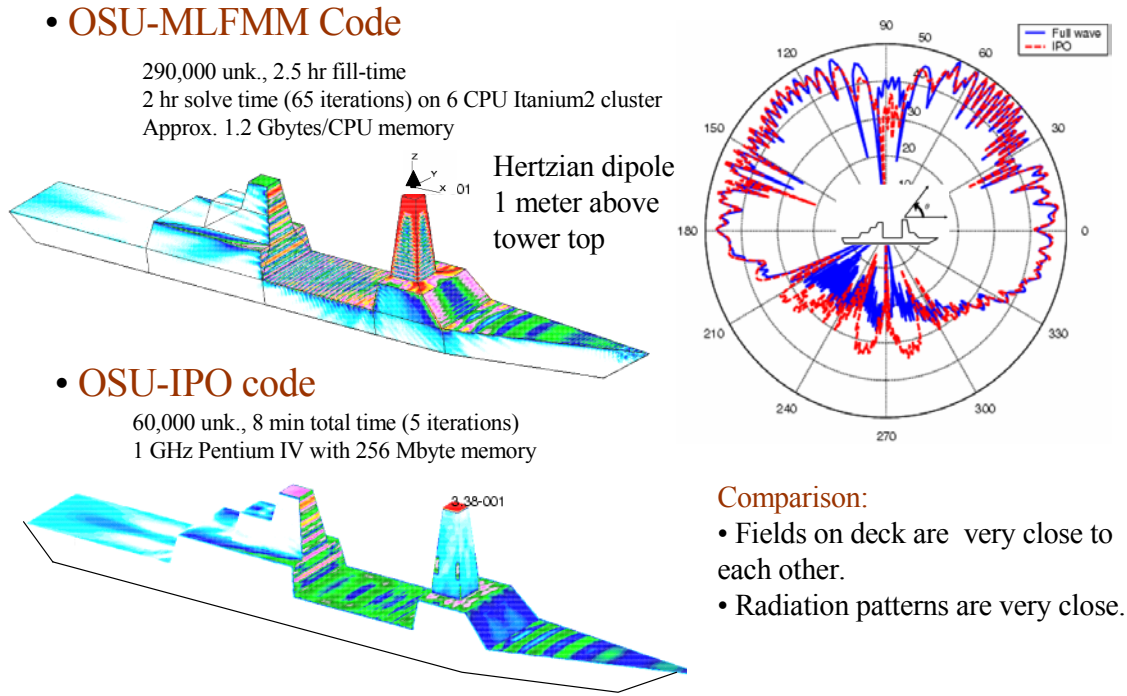

Figure 8: Validation of OSU-IPO method with the OSU-MLFMM code for a vertical dipole above the forward mast of a generic ship model. Frequency is at 200 MHz.

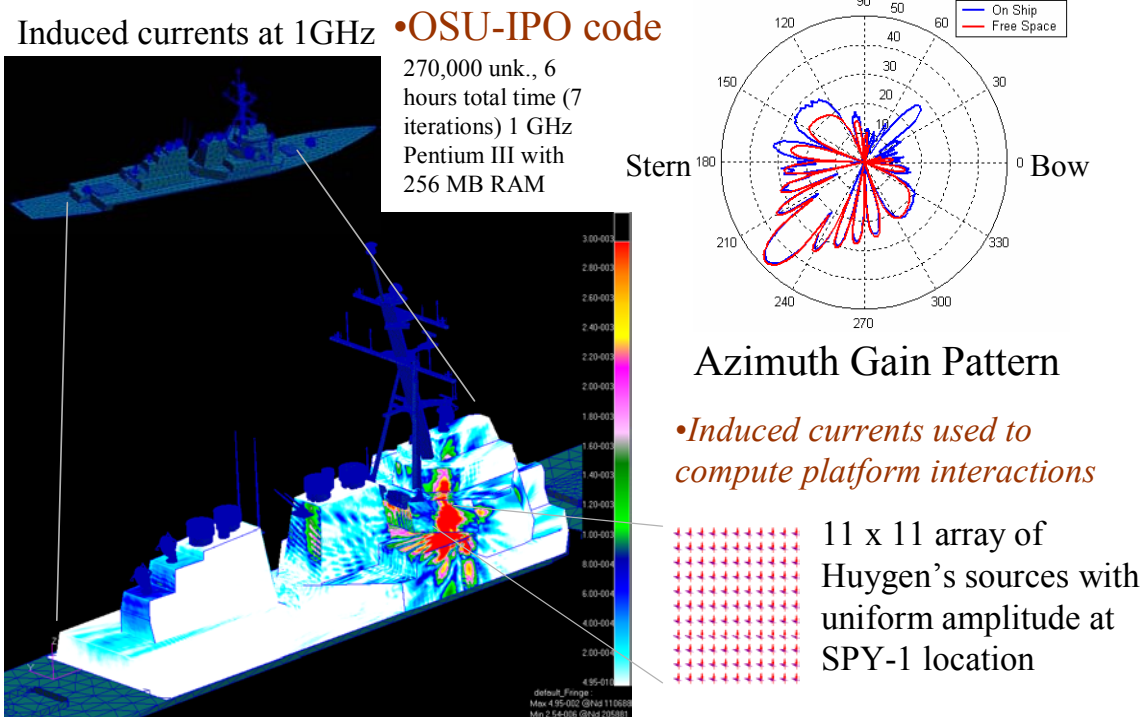

Figure 9: Induced currents on the DDG-52 cruiser model excited by an 11x11 array radiating at 1 GHz.

At this point, we can state that the OSU-IPO code may be used to model ship topsides for frequencies of up to about 4 GHz without resorting to supercomputers. Work is also in progress to implement the asymptotic phasefront extraction (APEX) technique [19] to extend the method of moments (MoM) to as high or higher frequencies as IPO by incorporating frequency-scalable basis functions [20].

At even higher frequencies it becomes necessary to employ the uniform geometrical theory of diffraction (UTD) ray method to account for the platform effects. Thus, the Ohio State University Basic Scattering Code (OSU-BSC) [5] (which employs UTD) is utilized here for evaluating the relevant dominant UTD ray field interactions as described below. It is also possible to employ UTD to describe the fields radiated locally from the arrays themselves. This is necessary to transform the boundary integral basis functions into ray fields that can propagate throughout the platform environment.

Demonstration of Hybrid MoM/UTD Method

In the discussion below, an example involving the EM wave interactions between apertures/arrays with their ship platform is provided using a hybrid method of moments (MoM)/UTD approach. As noted above, such a hybrid approach is useful at high frequencies for which the ship platform becomes electrically very large and a full MoM or FE-BI analysis, as well as the IPO, tend to become intractable.

This example deals with the coupling between two conformal slot arrays on the same face, or different faces, of a large perfectly conducting ship tower model as shown in Figure 10. The array current distribution for a given excitation is found via the numerical MoM solution to the governing array integral equation for the unknown currents. (The current distribution could also have been computed by FE-BI, but the slot array is simple enough to use the ordinary MoM.) The UTD is then used for computing the interaction of array currents with the ship structure.

In a broader sense, one may state that the ship Green's function forms the kernel of the integral equation governing the boundary integrals in (1)-(4). In general, there is no analytical closed form expression for the ship/platform Green's function

except at high frequencies where it can be approximated in closed form by the UTD. The UTD can model almost all of the electrically large ship structure except for those portions with electrically small features, or with electrically large features for which the UTD diffraction coefficients are presently not available. For the more complex antenna array configurations that are recessed in the ship platform, the procedure is slightly modified and requires a separate array code (such as the AD-FMM code) to provide the fields in the equivalent aperture formed by such arrays.

As seen in Figure 10, array A is transmitting, whereas arrays B and C are both receiving. The UTD ray coupling, or the dominant rays for the UTD Green's function pertaining to the tower over a ground plane are also illustrated in Figure 10(a). The slot array geometry is shown in Figure 10(b).

The only unknowns in the numerical MoM solution are those associated with the slot aperture electric fields (because the UTD Green's function for the tower accounts for the rest of that structure with the slots now closed by conducting surfaces). The slots are fed by a waveguide and are all identical, and sufficiently short and narrow so that a usual dominant vector mode function (emulating the waveguide mode) can be assumed for each slot-electric field. The UTD is applied by considering each slot as a weighted point source from which rays may be traced [21]. These UTD fields are then employed within the MoM solution in a self consistent manner for both transmitting and receiving arrays [22]. However, the receiving and transmitting arrays can also be considered separately, and then coupled numerically in an iterative fashion using (4).

Figure 11(a) shows the coupling to array B with array A transmitting and array C absent, whereas Figure 11(b) shows the coupling to Array C with B absent. The slots of A are excited uniformly and phased to radiate broadside. We also note that the slots are oriented horizontally in Figure 11(a) and vertically in Figure 11(b). Taking into account the different color scales in the figures, it is clear that the co-planar coupling is much higher than the "around the corner" coupling, as expected.

This UTD-based Green's function for the tower incorporated within the integral equation MoM solution of Figure 11 can be extended to

include not only the interaction of the arrays in the presence of the tower, but also in the presence of the entire ship structure. The rays for the UTD ship Green's function (in contrast to the dominant UTD rays for just the tower only) are shown in Figure 12(a). The UTD coupling between a slot

on one face of the ship tower and another slot on the same or different face is plotted as a function of separation distance in Figure 12(b).

We next proceed to introduce large aperture basis functions for modeling the array in conjunction with the UTD or IPO.

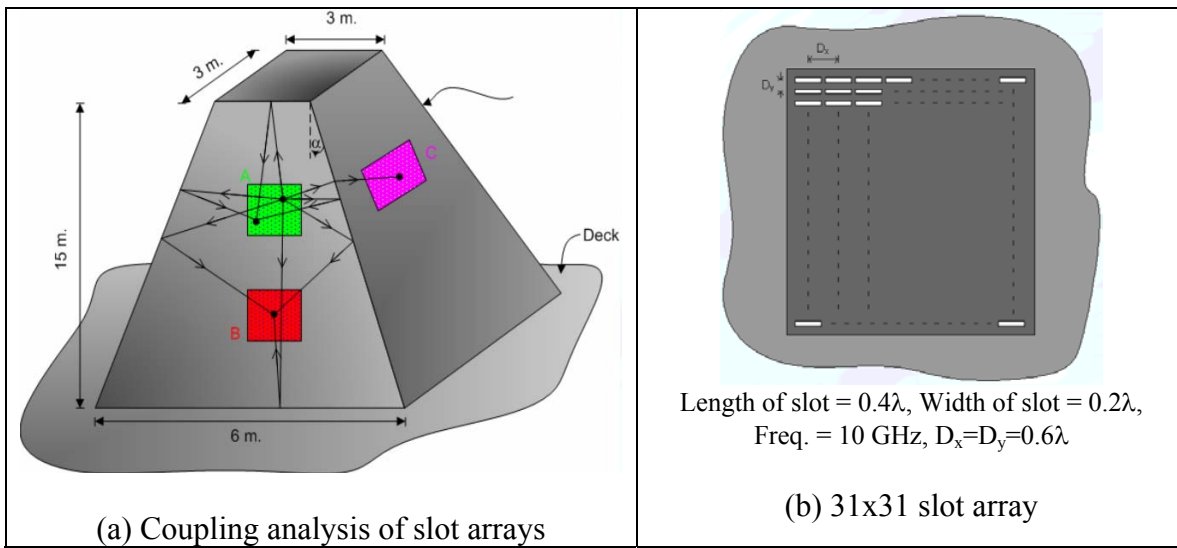

Figure 10: Dominant ray interactions between the excited 31x31 slot array A and the 31x31 receiving slot arrays B and C, respectively.

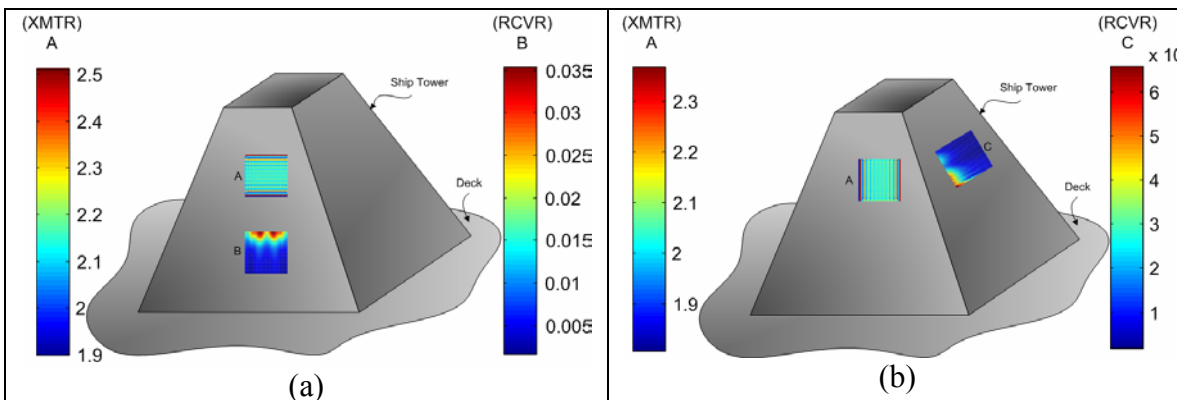

Figure 11: The array distribution on the transmitting slot array A and the receiving slot arrays B and C, respectively.

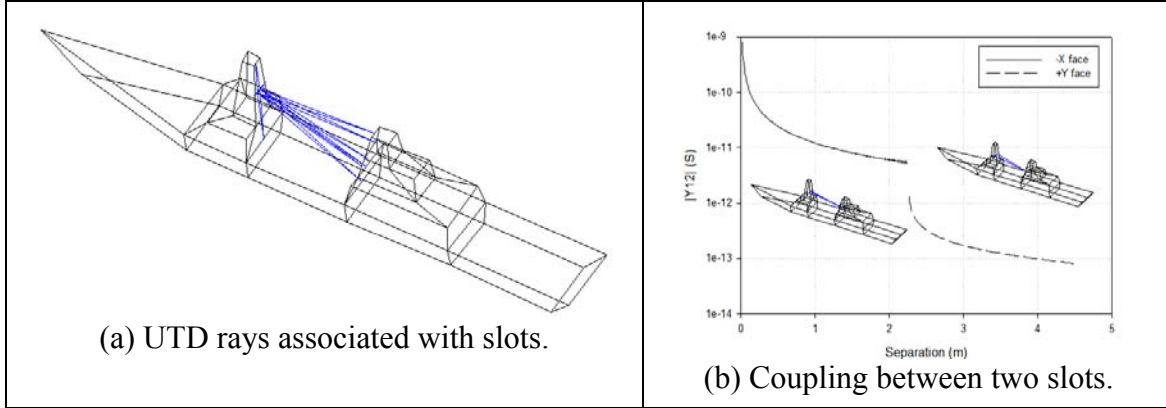

Figure 12: UTD analysis of coupling between two slots on ship tower. Blue lines on ship are UTD rays.

V. TRUNCATED DFT ARRAY APERTURE BASIS FUNCTIONS

In the boundary integral approach to interfacing an array antenna with the external platform, the number of conventional sub-sectional basis functions on the interface can be quite large. Therefore, the dense interaction matrices $Z_{ij}|_{i \neq j}$ in (2) and (4) can be extremely large and the computation of the MVP in (7) very CPU intensive. Further, to apply/integrate the standard FE/BI (with no basis reduction) with IPO or UTD each element or weighted source must be treated individually, making the implementation rather cumbersome and highly inefficient since each elemental source launches its own UTD rays [21]. That is, since rays are traced from all the point sources of the transmitting antenna to all of the points on the receiving antenna, N array elements on each aperture implies $O(N^2)$ rays need to be traced. Considering the time it takes to track a single ray through a complex platform environment, tracking this many rays may not be tractable for complex structures (ships or aircraft).

A simple approach for reducing the number of source points is based on the generalized ray expansion (GRE) depicted in Figure 13. The GRE subdivides an aperture into a set of smaller sub-apertures (not antenna elements) [23]. Rays are then launched from the phase center of each sub-aperture and weighted according to the composite far-field pattern of all the point sources included within the sub-aperture. The rays are subsequently traced to each of the sub-aperture phase centers of the receiving array and weighted by the receiving

sub-aperture pattern. For example, if there are M sub-apertures in each array, then $O(M^2)$ rays need be traced. (M is chosen to be as small as possible under the restriction that all nearby scattering structures and antennas are in the far-field of each sub-aperture.) Typically, each sub-aperture may be on the order of 2-5 wavelengths and could contain 400-2500 small basis functions.

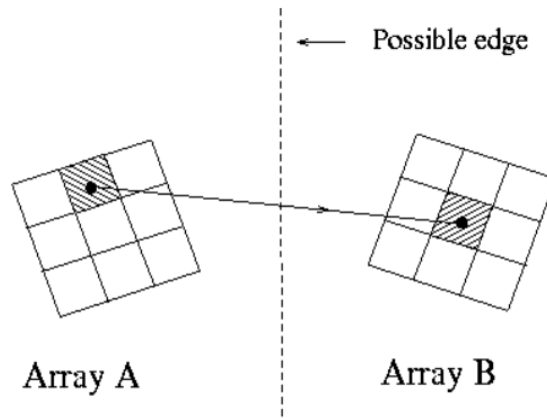

Figure 13: Generalized ray expansion for sub-aperture interactions.

A more sophisticated approach is to employ a discrete Fourier transform (DFT) representation for the fields across the large array aperture. This representation has been shown to provide the same information more compactly when properly truncated [8,24]. Such a truncated DFT which retains only relatively few significant terms may be shown to be very efficient for representing the aperture fields. Rules have also been established to select the significant DFT components (usually 20% or so of the total discrete number of elements

or samples in the aperture). Figure 14 shows a realistic 31×31 slot array current distribution and the corresponding DFT spectrum for a uniform excitation. The truncated DFT keeps a certain number of terms in the bands around the $l=0$ and $k=0$ spectral lines, where the DFT spectrum is most concentrated. The radiated array field (AF) is plotted in the near zone along the diagonal direction 300λ above the array. As can be seen from this figure, the truncated DFT (with 20% significant terms) is very accurate and agrees well with the exact solution (DFT with all N terms). In some cases it may be necessary to include a small additional set (about 25 more DFT components) within a narrow (5×5) sliding spectral window centered about the DFT component closest to the observation direction [22]. The sliding window correction is shown in the array field results of Figure 14.

As the above example shows, the actual spatially sampled array aperture fields can vary rapidly over the aperture, especially near the finite array edges. The more compact DFT set has the advantage of having large basis functions that are uniform in amplitude with linear phase. It has been shown recently that each DFT basis over a large array generates an efficient closed form UTD ray field representation for the entire array radiation at once [22]. These DFT based UTD rays emanate from certain flash points on the array boundary and one interior point, as shown in Figure 15. Four edge rays are analogous to UTD edge diffraction, four corner rays are analogous to UTD vertex diffraction, and one interior ray is analogous to the geometrical optics ray. Thus the DFT also provides a simple physical picture for the formation of the near and far fields using only a handful of UTD rays that reach an observer in the external region. Furthermore, *the number of UTD*

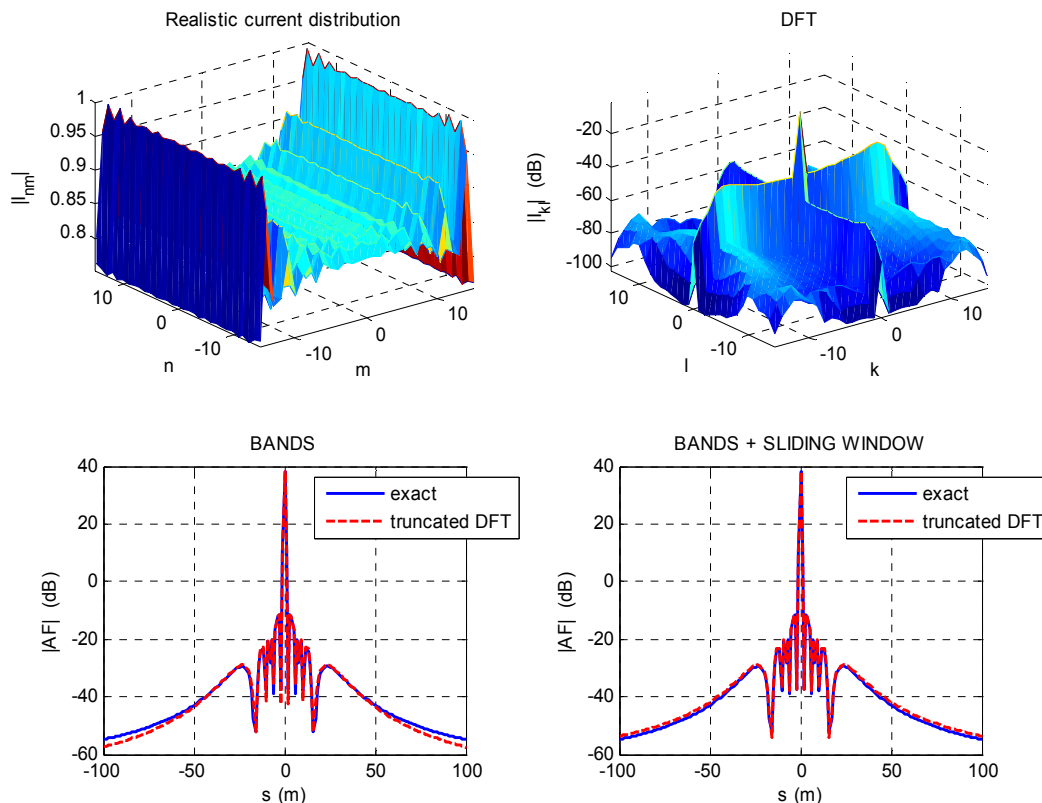

Figure 14: Array distribution for a uniformly excited array including mutual coupling effects, and its DFT spectrum. A sliding window technique is introduced to improve the accuracy from truncating the DFT spectrum.

rays from each significant DFT component stays the same even if the physical dimensions of the array are made larger!

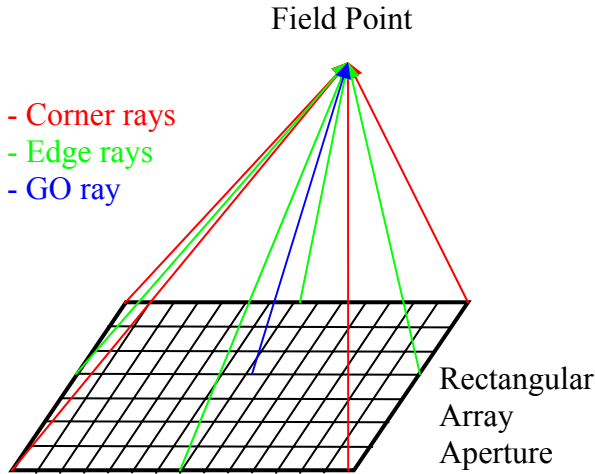

Figure 15: Analogous UTD rays emanating from a rectangular array.

These DFT based UTD rays may emanate from flash points on one array to all the appropriate and corresponding flash points on

another array boundary. Some of these ray interactions are shown in Figure 16 for two arrays that are co-planar or on adjacent faces of a ship tower.

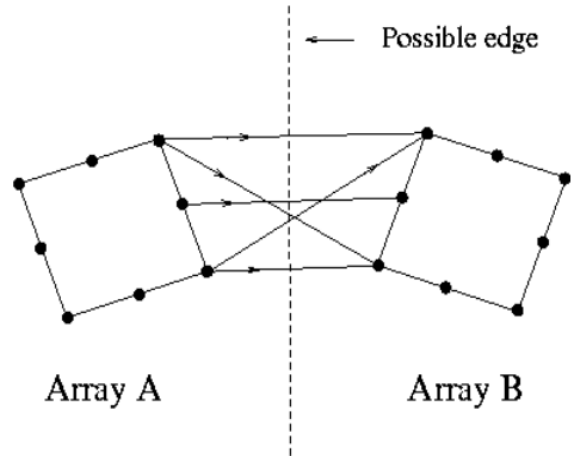

Figure 16: Only a few UTD ray flash points on the boundary array A interact with those of array B to describe the entire coupling of array A to array B via the DFT representation.

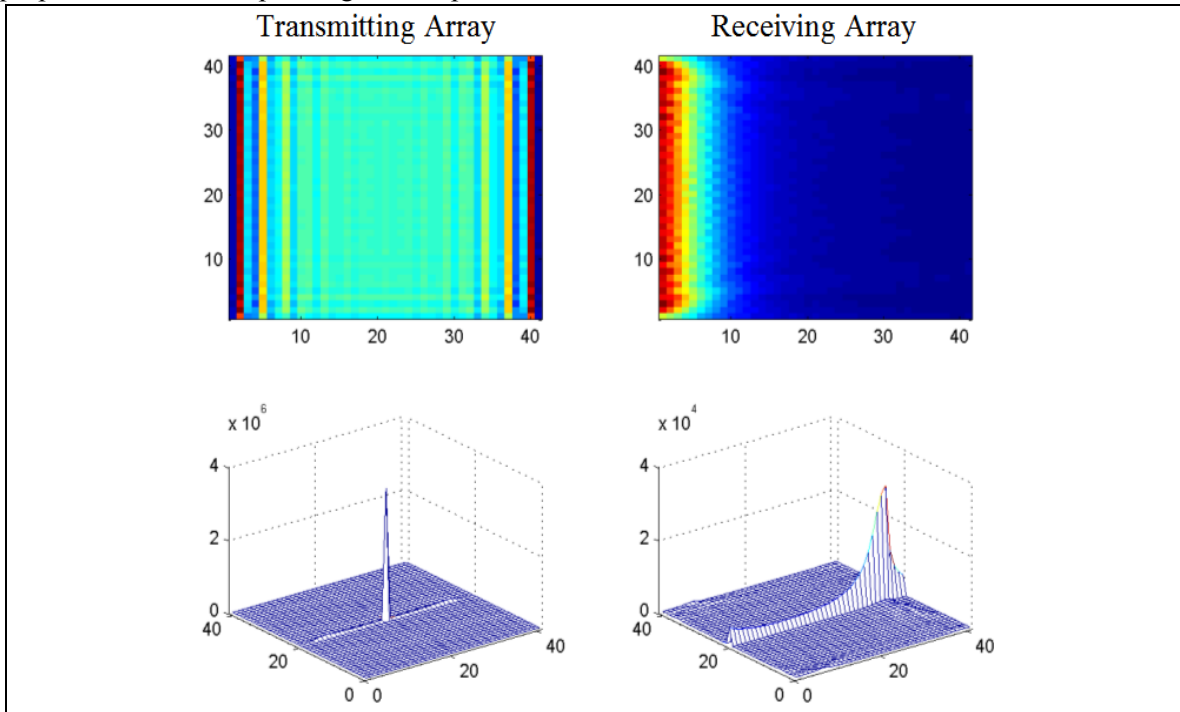

Figure 17: Transmitting and receiving array distributions in the top figures when the transmitting array is uniformly excited. The corresponding DFT spectra for the transmitting and receiving apertures are shown at the bottom. The left hand side top and bottom figures are for the transmitting array and the right hand side is for the receiving case (The color scale for the receiver is scaled by a factor of 100).

It is evident from the above figures that the DFT spectrum is highly localized; i.e., the significant DFT components are highly peaked in a small portion of the entire DFT space. Thus the computational complexity of this method for array aperture to aperture coupling is of $O(PQ)$ where P is the number of significant DFT terms retained for the transmitting array, and Q is the corresponding number for the receiving array. Since P and Q are expected to be significantly less than the number of discrete aperture samples N , this method has the potential to be very efficient. It is shown in Figure 17 that the DFT spectra of a transmitting slot array (as in Figure 10(b)) and that of the receiving slot array (also as in Figure 10(b)) are quite compact when both arrays lie on the same ground plane. It is therefore expected that the coupling between the arrays may be calculated quite efficiently using the proposed approach.

More recently, the DFT approach has been generalized in the context of the traveling wave (TW) expansion that is even more efficient than the DFT approach [9]. However, due to space limitations, this new TW basis will not be described here; it will form the subject of a future publication.

VI. SUMMARY REMARKS

A general matrix formulation has been presented to decouple the antenna analysis from the platform by virtue of the natural domain decomposition feature of the FE-BI method. The interactions between the antenna and platform, and other antennas, are computed via high-frequency asymptotic methods interfaced to the antenna via the boundary integral. The latter is implemented in the context of the AD-FMM for very large arrays with very low memory requirements. For coupling among the arrays, the DFT approach provides a reduced representation of the aperture fields so that far fewer rays need to be traced between array apertures and their complex platforms.

Full-size ships and realistic shipboard array antennas can now be analyzed with this hybrid methodology. For example, a hybrid calculation of the radiation pattern of a stacked circular patch array mounted conformally on a 737 fuselage is illustrated in Figure 18. This calculation used a hybrid combination of the FE-BI for modeling the actual array + DFT-UTD for modeling the array

aperture + UTD for the local cylindrical fuselage simulation [25]. Details of such a hybrid approach for a realistic conformal airborne antenna array analysis will be described in a separate publication.

REFERENCES

- [1] W. D. Burnside, M. C. Gilreath, R. J. Marhefka and C. L. Yu, "A study of KC-135 aircraft antenna patterns," *IEEE Trans. Antennas and Propagation*, Vol. 23, No. 3, pp. 309-316, May 1975.
- [2] J. J. Kim and W. D. Burnside, "Simulation and Analysis of Antennas Radiating in a Complex Environment," *IEEE Trans. Antennas and Propagation*, Vol. 34, No. 4, pp. 554-563, April 1986.
- [3] W. D. Burnside and R. J. Marhefka, "Antennas on Aircraft, Ships, or any Large Complex Environment," Chapter 20 in *Antenna Handbook: Theory, Application and Design*, eds. Y. T. Lo and S. W. Lee, Van Nostrand Reinhold, Inc., New York, 1988.
- [4] R. W. Kindt, K. Sertel, E. Topsakal and J. L. Volakis, "Array decomposition method for the accurate analysis of finite arrays," *IEEE Trans. Antennas Propagat.*, Vol. 51, No. 6, pp. 1364-1372, June 2003.
- [5] R. J. Marhefka, "Numerical Electromagnetic Code—Basic Scattering Code (NEC-BSC Version 4.2), User's Manual," The Ohio State University ElectroScience Lab Technical Report, June 2000.
- [6] F. Obelleiro, J. L. Rodriguez, and R. J. Burkholder, "An Iterative Physical Optics Approach for Analyzing the Electromagnetic Scattering by Large Open-Ended Cavities," *IEEE Trans. Antennas Propagat.*, Vol. 43, No. 4, pp. 356-361, April 1995.
- [7] F. Obelleiro, J. M. Taboada, J. L. Rodriguez, and J. M. Bertolo, "HEMCUVI: A Software Package for the Electromagnetic Analysis and Design of Radiating Systems On Board Real Platforms," *IEEE Antennas and Propagation Magazine*, Vol. 44, No. 5, pp. 44-61, Oct. 2002.
- [8] P. Janpugdee, P. H. Pathak, P. Mahachoklertwattana and R. J. Burkholder, "An Accelerated DFT-MoM for the Analysis of Large Finite Periodic Antenna Arrays,"

- IEEE Trans. on Antennas and Propagation*, Vol. 54, No. 1, pp. 279-283, Jan. 2006.
- [9] P. Janpugdee, P. H. Pathak and R. J. Burkholder, "A new traveling wave expansion for the UTD analysis of the collective radiation from large finite planar arrays," *IEEE Antennas and Propagation Society/URSI Symposium, Washington, D.C.*, 3-8 July 2005.
- [10] M. Carr and J. L. Volakis, "Domain Decomposition by Iterative Field Bouncing," *IEEE APS/URSI Intl. Symp. Digest*, Vol. 3, pp. 298-301, 16-21 June 2002.
- [11] J. M. Song, C. C. Lu and W. C. Chew, "Multilevel fast multipole algorithm for electromagnetic scattering by large complex objects," *IEEE Trans. on Antennas and Propagation*, Vol. 45, No. 10, pp. 1488-1493, Oct. 1997
- [12] K. Sertel and J. L. Volakis, "Multilevel fast multipole method solution of volume integral equations using parametric geometry modeling," *IEEE Trans. Antennas Propagat.*, Vol. 52, No. 7, pp. 1686-1692, July 2004.
- [13] J. L. Volakis, A. Chatterjee and L. C. Kempel, *Finite Element Method for Electromagnetics*, IEEE Press, New York, 1998.
- [14] R. W. Kindt and J. L. Volakis, "Array Decomposition-Fast Multipole Method for finite array analysis," *Radio Science*, vol. 39, no. 216, April 2004.
- [15] R. Coifman, V. Rokhlin and S. Wandzura, "The Fast Multipole Method for the Wave Equation: A Pedestrian Prescription," *IEEE Antennas and Propag. Mag.*, Vol. 35, No. 3, June 1993.
- [16] P. H. Pathak and R. J. Burkholder, "High Frequency Scattering," Section 1.5.2 in *Scattering: Scattering and Inverse Scattering in Pure and Applied Science*, pp. 245-276, eds E. R. Pike and P. Sabatier, Academic Press, Ltd., London, 2002.
- [17] R. J. Burkholder, "A fast and rapidly convergent iterative physical optics algorithm for computing the RCS of open-ended cavities," *Journal of the Applied Computational Electromagnetics Society*, Vol. 16, No. 1, 2001.
- [18] C. C. Lu and W. C. Chew, "Fast far-field approximation for calculating the RCS of large objects," *Microwave and Opt. Tech. Letters*, Vol. 8, No. 5, pp. 238-241, 5 Apr., 1995.
- [19] D.-H. Kwon, R. J. Burkholder and P. H. Pathak, "Efficient Method of Moments (MoM) Formulation for Large PEC Electromagnetic Scattering Problems using Asymptotic Phasefront Extraction," *IEEE Trans. Antennas Propagat.*, Vol. 49, No. 4, pp. 583-591, April 2001.
- [20] R. J. Burkholder, P. H. Pathak, C. Tokgoz and C. J. Reddy, "Frequency-Scalable Basis Functions for the Iterative Physical Optics Method," *Annual Meeting of the Electromagnetic Code Consortium* Seattle, WA, 17-21 May 2004.
- [21] T. Ozdemir, M. W. Nurnberger, J. L. Volakis, R. Kipp and J. Berrie, "A Hybridization of Finite-Element and High-Frequency Methods for Pattern Prediction for Antennas on Aircraft Structures," *IEEE Antennas and Propagation Mag.*, Vol. 38, No. 3, June 1996.
- [22] K. Tap, T. Lertwiriayaprapa, P. H. Pathak and K. Sertel, "A hybrid MoM-UTD analysis of the coupling between large multiple arrays on a large platform," *IEEE Antennas and Propagation Society/URSI Symposium*, Washington, D.C., 3-8 July 2005.
- [23] R. J. Burkholder, R.-C. Chou and P. H. Pathak, "Two ray-shooting methods for computing the EM scattering by large open-ended cavities," *Computer Physics Communications – Thematic Issue on Computational Electromagnetics*, Vol. 68, Nos. 1-3, pp. 353-365, Nov. 1991.
- [24] P. Janpugdee, P. Pathak, P. Nepa, O. Civi & H-T. Chou, "Ray Analysis of the Radiation from a Large Finite Array of Antennas on a Grounded Material Slab," *USNC/URSI National Radio Science Meeting, Boston, Mass.*, 8-13 July 2001.
- [25] R. W. Kindt, P. Janpugdee, P. H. Pathak and J. L. Volakis, "Analysis of Large Finite Arrays Integrated into Curved Platforms," *IEEE Antennas and Propagation Society/URSI Symposium*, Washington, D.C., 3-8 July 2005.

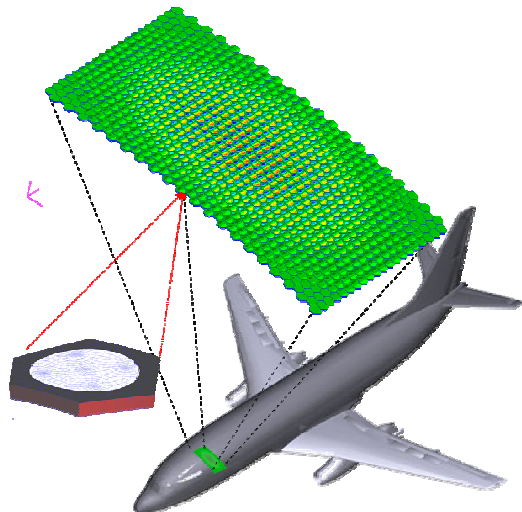

(a) X-band conformal array.

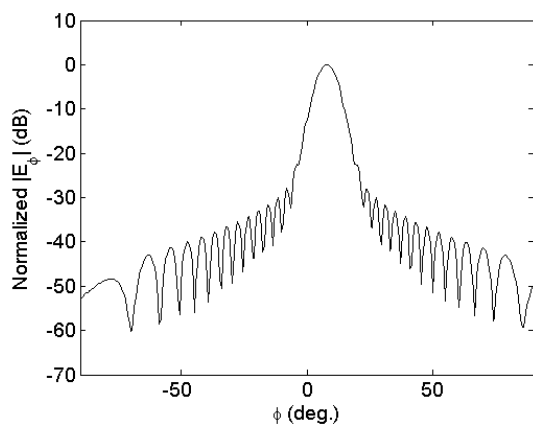

(b) Co-pol.

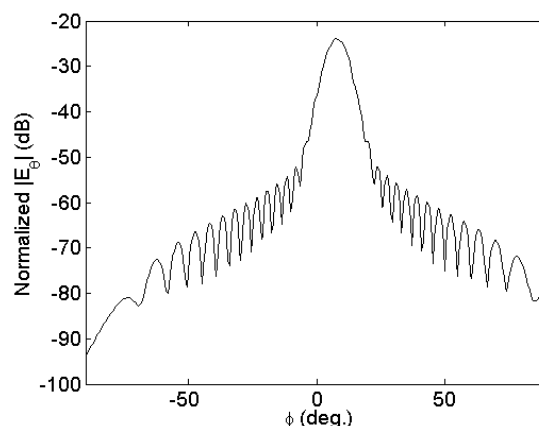

(c) Cross-pol.

Figure 18: Preliminary hybrid calculation of the radiation pattern at 9.5 GHz. of a cavity backed, stacked circular patch array mounted conformally on a 737 aircraft fuselage. Fuselage diameter = 12 ft.; $20 \times 20 \times 2$ (=800) array elements; 2×10^5 unknowns; 470 MB memory; 6 mins fill time; 20 sec solve time; 30 dB Taylor distribution on array.



Robert J. Burkholder received the B.S., M.S., and Ph.D. degrees in electrical engineering from The Ohio State University, Columbus, in 1984, 1985, and 1989, respectively.

Since 1989, he has been with The Ohio State University ElectroScience Lab, where he currently is a Senior Research Scientist and Adjunct Professor. Dr. Burkholder has contributed extensively to the EM analysis of large cavities, such as jet inlets/exhausts, and the scattering from targets over a rough sea surface. He is currently working on the more general problem of EM radiation, propagation and scattering in realistically complex environments. His research specialties are high-frequency asymptotic techniques and their hybrid combination with numerical techniques for solving large-scale electromagnetic radiation and scattering problems.

Dr. Burkholder is an elected Fellow of the IEEE, a member of the Applied Computational Electromagnetics Society, a member of the American Geophysical Union, and an elected Full Member of URSI Commission B. He served as an Associate Editor for IEEE Transactions on Antennas and Propagation from 1994 to 1999, and is currently an Associate Editor for *IEEE Antennas and Wireless Propagation Letters*.



Rick W. Kindt received the B.S.E. degree in 1998, the M.S.E. degree in 2000, and the Ph.D. degree in 2004, all in electrical engineering from the University of Michigan, Ann Arbor. His research specialty is the numerical modeling of large, quasi-

periodic structures, such as finite antenna arrays. In 2004 and 2005 he was a Postdoctoral Research Associate at the Ohio State University ElectroScience Lab. He is currently employed at the Naval Research Labs, Radar Division, Washington, D.C.



Prabhakar H. Pathak received his Ph.D degree from the Ohio State University, Columbus, Ohio, USA, in 1973, where he is currently a Professor. His main area of research is in the development of uniform asymptotic theories (frequency and time

domain) and hybrid methods for the analysis of large electromagnetic antenna and scattering problems of engineering interest. He is one of the major contributors to the development of the uniform geometrical theory of diffraction (UTD). He has also analyzed the scattering from large inlet cavities via hybrid ray and modal/numerical methods. Recently he has developed new fast asymptotic/hybrid methods which provide physical insights into the radiation mechanisms, for the analysis/design of modern satellite antennas such as large reflector systems and large phased arrays. Professor Pathak has presented many short courses and invited lectures both in the U.S. and abroad. He was invited to serve as an IEEE Distinguished Lecturer from 1991 through 1993. He also served as the chair of the IEEE Antennas and Propagation Distinguished Lecturer Program during 1999-2005. Prior to 1993, he served as an Associate Editor of the IEEE Transactions on Antennas and Propagation for two consecutive terms. He received the 1996 Schelkunoff best paper award from the IEEE (Institute of Electrical and Electronics Engineers) Transactions on Antennas and Propagation. He received the George Sinclair award in 1996 for his research contributions to the O.S.U. ElectroScience Laboratory. In July 2000, Prof. Pathak was awarded the IEEE Third Millennium Medal from the Antennas and Propagation Society. He was elected an IEEE Fellow in 1986, and is an elected member of US Commission B of the International Union of Radio Science (URSI).



Kubilay Sertel was born on June 27, 1973, in Tekirdag, Turkey. He received the B.S. degree from Middle East Technical University, Ankara, Turkey in 1995, the M.S. degree from Bilkent University, Ankara, Turkey in 1997, and the Ph.D. degree from the

Electrical Engineering and Computer Science Department at the University of Michigan, Ann Arbor, MI in 2003, respectively.

He is currently a Senior Research Associate at the ElectroScience Laboratory at the Ohio State University. His research areas include electromagnetic theory, computational electromagnetics, volume-surface integral equations and hybrid methods, fast and efficient methods for large-scale electromagnetics problems and parallel implementations of fast algorithms.



Ronald J. Marhefka received the B.S.E.E. degree from Ohio University, Athens, in 1969, and the M.Sc. and Ph.D. degrees in electrical engineering from The Ohio State University, Columbus, in 1971 and 1976, respectively. Since 1969, he has been with

The Ohio State University ElectroScience Laboratory where he is currently a Senior Research Scientist and Adjunct Professor.

His research interests are in the areas of developing and applying high frequency asymptotic solutions such as the Uniform Geometrical Theory of Diffraction, hybrid solutions, and other scattering techniques. He has applied these methods to numerous practical antenna and scattering problems, including airborne, spacecraft and shipboard antenna analysis and radar cross section prediction. He is the author of two user oriented computer codes,

the NEC - Basic Scattering Code and one dealing with radar cross section. The codes are being used in over 300 government, industrial, and university laboratories in the U. S. and 15 countries. In addition, he is the co-author with John Kraus on the textbook *Antennas, Ed. 3*, McGraw-Hill, 2002.

He was a co-author on papers that won the *IEEE Transactions on Antennas and Propagation* Best Application Paper Award in 1976 and the R. W. P. King Paper Award in 1976. He received the IEEE Third Millennium Medal in 2000. In addition, he was the recipient of the Applied Computational Electromagnetics Society's 1993 Technical Achievement Award. Dr. Marhefka is a Fellow of IEEE and has been elected to Tau Beta Pi, Eta Kappa Nu, Phi Kappa Phi, Sigma Xi, and Commission B of URSI. He has served as an officer of the local IEEE Antenna and Propagation and Microwave Theory and Techniques Societies during 1977-1980. He served as Associate Editor of the *IEEE Transactions on Antennas and Propagation* from 1988-1992 and was Editor from 1992-1995. He was elected a member of ADCOM in 1996, Vice President in 1997, and President in 1998. He was co-chair of the Technical Program Committee for the 2003 IEEE APS/URSI Symposium. In addition, he has chaired the AP-S Publications Committee, from 1996-2003. He also is an Associate Editor of the *Applied Computational Electromagnetics Society Journal*.



John L. Volakis was born on May 13, 1956 in Chios, Greece and immigrated to the U.S.A. in 1973. He obtained his B.E. Degree, summa cum laude, in 1978 from Youngstown State Univ., Youngstown, Ohio, the M.Sc. in 1979 from the Ohio State Univ., Columbus, Ohio

and the Ph.D. degree in 1982, also from the Ohio State Univ.

From 1982-1984 he was with Rockwell International, Aircraft Division (now Boeing Phantom Works), Lakewood, CA and during

1978-1982 he was a Graduate Research Associate at the Ohio State University ElectroScience Laboratory. From January 2003 he is the Roy and Lois Chope Chair Professor of Engineering at the Ohio State University, Columbus, Ohio and also serves as the Director of the ElectroScience Laboratory (with ~\$7.5M in research funding). Prior to moving to the Ohio State Univ, he was a Professor in the Electrical Engineering and Computer Science Dept. at the University of Michigan, Ann Arbor, MI. (1984-2003). He also served as the Director of the Radiation Laboratory from 1998 to 2000. His primary research deals with computational methods, electromagnetic compatibility and interference, design of new RF materials, multi-physics engineering and bioelectromagnetics. Dr. Volakis is listed by ISI among the top 250 most referenced authors (2004, 2005).

Dr. Volakis served as an Associate Editor of the *IEEE Transactions on Antennas and Propagation* from 1988-1992, and as an Associate Editor of Radio Science from 1994-97. He chaired the 1993 IEEE Antennas and Propagation Society Symposium and Radio Science Meeting, and co-chaired the same Symposium in 2003. Dr. Volakis was a member of the AdCom for the IEEE Antennas and Propagation Society from 1995 to 1998 and served as the 2004 President of the IEEE Antennas and Propagation Society. He also serves as an associate editor for the *J. Electromagnetic Waves and Applications*, the *IEEE Antennas and Propagation Society Magazine*, and the URSI Bulletin. He is a Fellow of the IEEE, and a member of Sigma Xi, Tau Beta Pi, Phi Kappa Phi, and Commission B of URSI. He is also listed in several Who's Who directories, including Who's Who in America.