

Design and Implementation of a Wilkinson Power Divider with Integrated Band Stop Filters Based on Parallel-coupled Lines

Ravee Phromloungsri¹ and Somchat Sonasang²

Department of Computer and Communication Engineering
 Faculty of Technology UdonThani Rajabhat University, Udon Thani 41000, Thailand
 phravee@gmail.com

Department of Electronic Technology
 Faculty of Industrial Technology Nakhon Phanom University, Nakhon Phanom 48000, Thailand
 somchat.s@npu.ac.th

Abstract – This paper presents a technique to improve the spurious suppression performance at the second harmonic ($2f_0$) of a Wilkinson power divider. The technique is achieved by the insertion of bandstop filters realizing with parallel-coupled lines with the characteristic impedance of $2\sqrt{Z_0}\Omega$ and the electrical length of $\lambda/8$ in a conventional structure. The simulated and measured results of the conventional and the proposed divider are compared at 0.9 GHz. The insertion losses (S_{21} , S_{31}) are less than 3.1 dB, while the return losses (S_{11}) are less than 34.6 dB across 100% fractional bandwidth. Moreover, the proposed Wilkinson power divider achieves more than 25.5 dB suppression at $2f_0$.

Index Terms – band stop filter, harmonics suppression, parallel-coupled lines, Wilkinson power divider.

I. INTRODUCTION

The Wilkinson power divider, first introduced by Wilkinson [1], is an essential component for microwave and millimeter-wave applications. It is widely used because of its useful property of being perfectly matched at all ports, high isolation between the output ports [2] and power divider with harmonics suppression [3–5]. The Wilkinson power divider consists of two quarter-wavelength branches of transmission lines with a characteristic impedance $2\sqrt{Z_0}$ and a parallel resistor $2Z_0$ connecting two output ports as shown in Fig. 1 (a). A conventional Wilkinson power divider is designed based on the electrical length of a desired fundamental frequency. However, high-order harmonic signals appear at the output ports due to the periodic characteristics of a transmission line. In addition, using the quarter-wavelength transmission lines will unavoidably lead to poor selectivity in each transmission path. The selectivity can be improved by adding bandpass filters at the input or at each output port of the Wilkinson power divider. How-

ever, this approach is not suitable for a compact design [6–8].

Several researchers presented a Wilkinson power divider for reducing high-order harmonic frequency, such as a band pass filter using the open/short stub [9], third order bandpass filter high order [10], lowpass filter [11–12], and all mentioned above techniques can reduce the harmonics frequency suppression perfectly. Most techniques are limited due to their fabrication com-

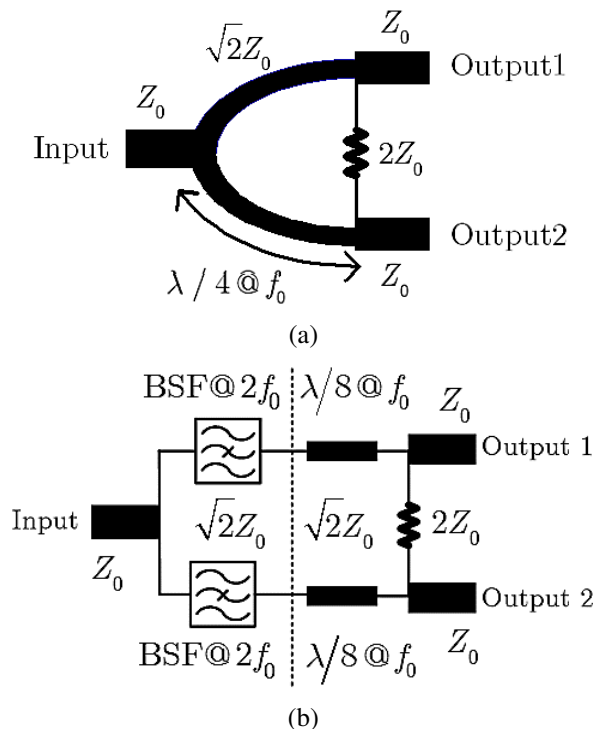

Fig. 1. Schematics of (a) conventional and (b) the proposed Wilkinson power divider with integrated band stop filter.

plexities. Employing a transmission line with inherent bandstop filter functionality, we propose a replacement of ordinary quarter-wavelength branches of transmission lines with the parallel-coupled lines bandstop filters as shown in Fig. 1 (b).

Section II presents the basic theory of the proposed bandstop filter based on parallel-coupled lines to suppress the harmonic signals. The proposed method also results in the suppression of $2f_0$ frequency response, as presented in Section III. The paper is finally concluded in Section IV.

II. THEORY

A. Band stop filter based on parallel-coupled lines

Band stop filters (BSF) are important components in microwave and modern wireless communications systems. Their potential applications are rejecting higher harmonics and spurious passband responses in transmission line circuits. A conventional band stop circuit with either a shunt stub or stepped-impedance transmission line is not suitable due to its large circuit size [9, 13–16]. Recently, some periodic materials such as photonic bandgap (PBG), electromagnetic bandgap (EBG), and defected ground structure (DGS) [17–19], have been shown to exhibit good band stop filter characteristics and are popularly applied in band stop filter designs. Their stopband bandwidth and sharp cutoff frequency response are enhanced by increasing the periodic cells, which leads to a larger size and more transmission loss in the stopband. Moreover, PBG, EBG, and DGS require an etching process on the backside ground plane, and additional position calibration increases time consumption and helps overcome some machining difficulties [9].

We proposed a simple design of a compact band stop filter using parallel-coupled lines as shown in Fig. 2. To suppress the second harmonic frequency response, the proposed band stop filter is designed and implemented by using a section of $\lambda/8$ parallel-coupled lines and cascaded with an ordinary $\lambda/8$ at the operating frequency f_0 as shown in Fig. 1 (b). The function of the integrated band stop filter is to suppress spurious response in the transmission coefficient (S_{21}) at the second harmonic. The equations of the input reflection coefficient (S_{11}) and forward transmission coefficient (S_{21}) of the proposed



Fig. 2. Schematic of the proposed 2-port band stop filter based on parallel-coupled lines.

circuit are obtained from the relationship of voltage, current, and impedance of a 4-port parallel-coupled lines network [10] as shown in Fig. 2. These relationships can be expressed in Equations (1)–(4) as shown [20–21]:

$$V_1 = Z_{11}I_1 + Z_{13}I_3 + Z_{14}I_4, \quad (1)$$

$$V_2 = Z_{21}I_1 + Z_{23}I_3 + Z_{24}I_4, \quad (2)$$

$$0 = Z_{31}I_1 + Z_{33}I_3 + Z_{34}I_4, \quad (3)$$

$$V_4 = Z_{41}I_1 + Z_{43}I_3 + Z_{44}I_4. \quad (4)$$

From Fig. 2, the 4-port network of parallel-coupled lines is transformed into a 2-port band stop filter, where port 1 and port 4 are the input and output ports, respectively. The initial conditions are $V_3 = 0$ and $I_2 = 0$ to obtain the relationship between voltage, current and impedance parameters of the 2-port band stop filter. We eliminate I_3 from Equation (1) and (4). Therefore, the current I_3 , which is a function of I_1 and I_4 as shown in Equation (5), is substituted into Equations (1) and (4), then the 2-port impedance matrix of the band stop filter is obtained as shown in Equation (6):

$$I_3 = -\frac{Z_{13}}{Z_{11}}I_1 - \frac{Z_{12}}{Z_{11}}I_4, \quad (5)$$

$$Z_{BSF} = \begin{bmatrix} (Z_{11} - Z_{13}^2/Z_{11}) & (Z_{14} - Z_{12}Z_{13}/Z_{11}) \\ (Z_{14} - Z_{12}Z_{13}/Z_{11}) & (Z_{11} - Z_{12}^2/Z_{11}) \end{bmatrix}, \quad (6)$$

where [21]:

$$Z_{11} = \frac{1}{2}(Z_{0e} \coth(\theta_e) + Z_{00} \coth(\theta_0))$$

$$Z_{12} = \frac{1}{2}(Z_{0e} \coth(\theta_e) - Z_{00} \coth(\theta_0))$$

$$Z_{13} = \frac{1}{2}(Z_{0e} \operatorname{csch}(\theta_e) - Z_{00} \operatorname{csch}(\theta_0))$$

$$Z_{14} = \frac{1}{2}(Z_{0e} \operatorname{csch}(\theta_e) + Z_{00} \operatorname{csch}(\theta_0)).$$

From Equation (6) $Z_{12T} = Z_{21T}$ and $Z_{11T}^1 Z_{22T}$, the 2-port impedance matrix of the bandstop filter is shown in Equation (7):

$$\begin{bmatrix} V_1 \\ V_2 \end{bmatrix} = \begin{bmatrix} Z_{11T} & Z_{12T} \\ Z_{21T} & Z_{22T} \end{bmatrix} \begin{bmatrix} I_1 \\ I_2 \end{bmatrix}. \quad (7)$$

The 2-port matrix in Equation (6) was used to calculate the input impedance (Z_{in}), the input port reflection coefficient (S_{11}) and the forward transmission coefficient (S_{21}) of the proposed band stop filter as in Equations (8), (9) and (10) [21, 22]:

$$Z_{in} = Z_{11T} - \frac{Z_{12T}^2}{(Z_{22T} + Z_0)}, \quad (8)$$

$$S_{11} = \frac{(Z_{11T}^2 - Z_0^2) - Z_{12T}^2}{(Z_{11T} + Z_0)(Z_{22T} + Z_0) - Z_{12T}^2}, \quad (9)$$

$$S_{21} = \frac{2Z_0 Z_{12T}}{(Z_{11T} + Z_0)^2 - Z_{12T}^2}. \quad (10)$$

Figure 3 shows the simulated results of the proposed band stop resonator in terms of S_{11} and S_{21} , where

the proposed bandpass filter is synthesized from a coupling factor of -10 dB parallel-coupled lines. Considering the inset figure shown in Fig. 3, the relevant voltage coupling factors of parallel-coupled lines for synthesizing the band stop filter are between -9 dB and -10 dB, which provides the best performance to suppress the spurious response at a frequency of $2f_0$. Therefore, in the proposed power divider, the band stop filters were synthesized from -10 dB coupling factor with characteristic impedance $Z_0 = 70.7\Omega$, the even and odd-mode impedances of coupled lines were $Z_{0e} = 98.09\Omega$ and $Z_{0o} = 50.95\Omega$, on Arlon AD-260A printed circuit boards with the following design parameters: $\epsilon_r = 2.60$, $h = 1.0$ mm, $\tan \delta = 0.0017$ at the operating frequency of 1.8 GHz.

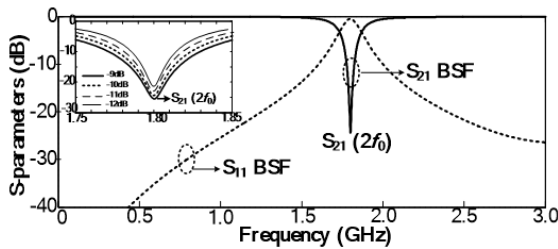

Fig. 3. Frequency response (S_{21}) and (S_{11}) of band stop filter based parallel-coupled lines.

B. The modified transmission line with integrated $2f_0$ band stop filter

The conventional Wilkinson power divider consists of two quarter-wavelength transmission lines with the characteristic impedance $\sqrt{2}Z_0$ connected between the input port and the two output ports. A resistor of $2Z_0$ connected between the output ports as shown in Fig. 1 (a). In this research, we insert the proposed band stop filter into each branch of a $\lambda/4$ transmission lines. Each transmission line is divided into two sections, as shown in Fig. 4. The first section is a $\lambda/8$ parallel-coupled-lines band stop filter, while the second part is an ordinary $\lambda/8$ transmission line. Both sections have characteristic impedances $\sqrt{2}Z_0$. These modified transmission lines have the same electrical length and characteristic impedance as the original design. However, it's particularly capable of suppressing the signal at the harmonic frequency $2f_0$ of the fundamental frequency of the Wilkinson power divider operating frequency due to the stop band network.

C. The proposed Wilkinson power divider with integrated $2f_0$ band stop filter

Based on the theories and concepts described in the previous section, a Wilkinson power divider capable of suppressing the second harmonic without adding a band

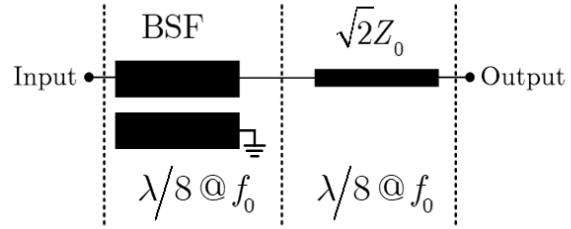

Fig. 4. The proposed synthetic transmission line with the integrated $2f_0$ spurious suppression band stop filter.

stop filter at the input port or the output ports is proposed. The band stop filter is integrated into the original design, as shown in Fig. 5. The replaced modified transmission lines maintain the original electrical properties of the conventional design. The size of the circuit is increased from the conventional circuit by 10% in the y-axis and increased by 10% when considering the overall area. The circuit design is simple, with minimal adjustments to the length of the transmission line to meet the desired operating frequency f_0 . The proposed Wilkinson power divider was designed and simulated on Arlon AD-260A printed circuit board. The integrated band stop filters were synthesized using a -10 dB coupling coefficient parallel-coupled lines with the following design parameters: $\epsilon_r = 2.60$, $h = 1.0$ mm, and $\tan \delta = 0.0017$ at the operating frequency of 0.9 GHz.

The insertion losses (S_{21} , S_{31}) and the input return loss (S_{11}), are not different from those of the conventional circuit. A significant change in the input return loss is achieved by the the coupled lines via holes. The simulated results in Fig. 6 show that, S_{11} of the proposed circuit (—) increases when compared to the conventional circuit (—) at the frequencies 0.9 GHz (f_0) and 1.8 GHz ($2f_0$), while, the S_{21} and S_{31} are preserved with -3 dB values in the range of the circuit bandwidth. The proposed circuit has the S_{21} , S_{31} suppression performance to less than -20 dB at the $2f_0$ or 1.8 GHz. However, parasitic inductance of the coupled

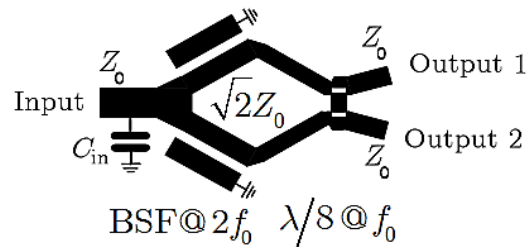

Fig. 5. Schematic of the proposed Wilkinson power divider with integrated BSF-based parallel-coupled lines and the shunted capacitance (C_{in}).

lines via holes significantly affects the return loss of the circuit. There are two approaches to tackle this. These are: 1) choose a printed circuit board with a thin substrate to reduce the inductance caused by the length of via ground and 2) add shunted capacitance (C_{in}) [13] at the input port as shown in Fig. 5 to improve the input matching.

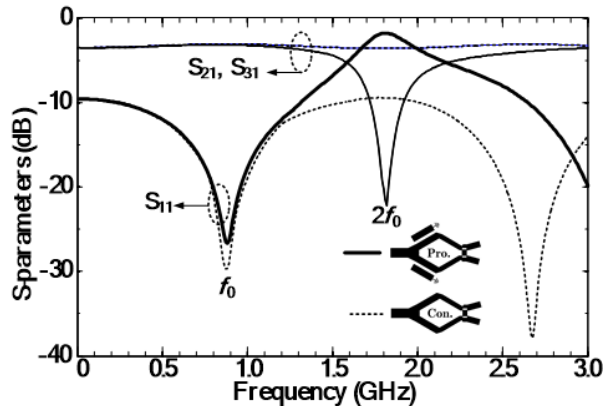

Fig. 6. Simulated frequency response of conventional and the proposed Wilkinson power divider.

III. DESIGN AND EXPERIMENTAL RESULTS

The proposed technique's performance is proven with a design of a 0.9 GHz operating frequency f_0 Wilkinson power divider. The circuit prototype is designed and fabricated on AD260A substrate ($\epsilon_r = 2.60$, $h = 1.0$ mm, $\tan \delta = 0.0017$). The band stop filters were synthesized in the proposed circuit from -10 dB coupling coefficient parallel-coupled lines with electrical parameters $Z_0 = 70.7\Omega$, $Z_{0e} = 98.09\Omega$, and $Z_{0o} = 50.95\Omega$. Table 1 shows the dimensions of the proposed Wilkinson power divider. The conventional Wilkinson power divider employs ordinary transmission lines with $W=1.50$ mm and $L=58.00$ mm at the electrical length of 0.5π . While the proposed Wilkinson power divider consists of two subcircuits, the first subcircuit used 0.25π at 0.9 GHz parallel-coupled-lines with $W = 1.2$ mm, $S = 0.30$ mm, and $L = 19.00$ mm. For the second subcircuit, a 0.25π transmission line with $W = 1.50$ mm, and $L = 29.00$ mm is employed. In the proposed circuit, the modified transmission line consists of a band stop filter based on $\lambda/8$ parallel-coupled lines operating at the frequency $2f_0$ of the Wilkinson power divider circuit cascaded with an ordinary $\lambda/8$ transmission line. This research used Sonnet-Lite and Matlab for simulation, data processing, and display. The simulated results of both circuits are shown in Fig. 6. The experiment was performed with an S5065 Vector Network Analyzer from Copper Mountain calibrated the frequencies from 0.1 to 3 GHz.

Table 1: The Wilkinson power divider circuits' physical dimensions

Wilkinson Power Divider	W,S,L (mm)	Electrical Length (rad)
Conventional	Ordinary lines W=1.50, L= 58.00	0.5π
Wilkinson with BSF	Ordinary Lines W=1.50, L= 29.00	0.25π
	BSF Coupled Lines W= 1.20, S=0.30, L=19.00	0.25π

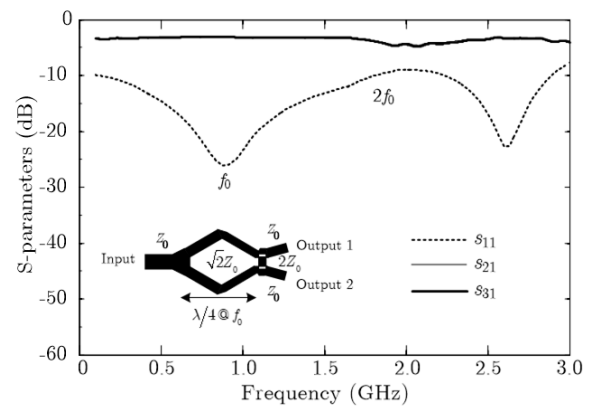

(a)

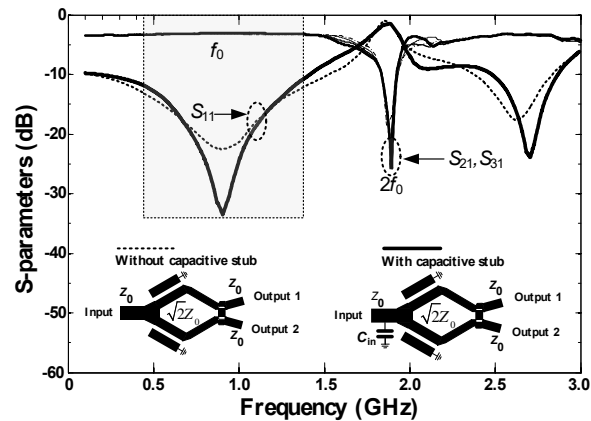

(b)

Fig. 7. Measured results of (a) conventional and (b) the proposed Wilkinson power divider with integrated band stop filters.

The measured results of the conventional power divider are shown in Fig. 7 (a). The values of the insertion loss S_{21} and S_{31} are approximately -3.00 dB, at frequencies from 0.1 to 3.0 GHz, while the S_{11} is less than -25.00 dB at 0.9 GHz and -10.10 dB at 1.8 GHz. In Fig. 7 (b), the insertion losses S_{21} , S_{31} , and return loss S_{11} of the proposed Wilkinson power divider

Table 2: The measurement S-Parameters of the circuits

Wilkinson Power Divider	Frequency (MHz)	% BW
Conventional	1,066	118
Wilkinson with BSF	1,255	136

Table 3: The comparison of Wilkinson power dividers

Ref.	Frequency (GHz)	Techniques	Implementation
[3]	1.65	Open stubs	Complicated
[4]	3.00	Parallel-coupled Line	Complicated
[5]	1.80	Open ended stubs	Complicated
[10]	2.45	Microstrip bandpass	Complicated
[20]	0.90	STIL compensated	Simple
This work	0.90	BSF coupled lines	Simple

around the operating frequency of 0.9 GHz are -3.10 dB and less than -34.60 dB with the input capacitive stub employed.

More than 100% fractional bandwidth is obtained, and the insertion loss' suppression performance at $2f_0$ is approximately more than -25 dB. Comparing the abilities of the proposed Wilkinson power divider and the conventional designs, the fractional bandwidths are 136 % and 118%, as shown in Table 2. Photographs of the conventional and the proposed Wilkinson power divider printed circuit boards with integrated band stop filter-based parallel-coupled lines are shown in Figs. 8 (a) and 8 (b). The circuit sizes, excluding the input and output connectors, of conventional and the proposed Wilkinson power divider, are approximately 24.5 cm² and 18.24 cm². The proposed circuit is 25% smaller than the conventional circuit.

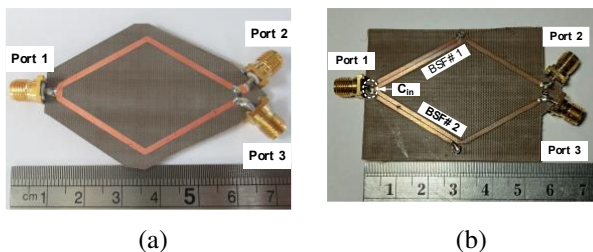

Fig. 8. PCB photograph of (a) conventional and (b) the proposed Wilkinson power divider with integrated BSF-based coupled lines and the shunted capacitance (C_{in}) at the input port.

Table 3 summarizes previous works and the proposed circuit. Our design is based on band stop filter coupled lines, which is simple, while the other designs are more complicated. Therefore, the proposed Wilkinson power divider is more suitable in terms of implementation.

IV. CONCLUSION

A simple technique to improve the spurious response suppression at the second harmonic of a Wilkinson power divider by inserting a compact band stop parallel-coupled lines in the original circuit has been presented. The proposed technique has several distinct features, such as low insertion and returns losses, good selectivity in each output signal path, excellent spurious suppression, and simple design and implementation. Based on the experiment, the spurious response of the proposed Wilkinson power divider is more than 28 dB at the second harmonic. Therefore, the technique has potential for modern microwave and wireless communications.

ACKNOWLEDGMENT

The authors would like to demonstrate gratitude toward the Faculty of Industrial Technology of the Nakhon Phanom University for research time and the Department of Computer and Communication Engineering (CCE), Faculty of Technology, Udon Thani Rajabhat University (UDRU) for research grant, instrumentation and materials support.

REFERENCES

- [1] E. J. Wilkinson, "An n-way hybrid power divider," *IRE Trans. Microw. Theory Tech.*, vol. 8, no. 1, pp. 116-118, Jan. 1960.
- [2] D. M. Pozar, *Microwave Engineering*, John Wiley & Sons, New York, 2011.
- [3] M. Hayati and S. Roshani, "A novel Wilkinson power divider using open stubs for the suppression of harmonics," *Applied Computational Electromagnetics Society (ACES) Journal*, vol. 28, no. 6, pp. 501-506, June 2013.
- [4] X. Yu, S. Sheng, and L. Yun, "Design of wideband filtering power dividers with harmonic suppression based on the parallel-coupled line structures," *Applied Computational Electromagnetics Society (ACES) Journal*, vol. 33, no. 5, pp. 468-475, May 2018.
- [5] S. Roshani, S. Koziel, S. Roshani, M. B. Jamshidi, F. Parandin, and S. Szczepanski, "Design of a patch power divider with simple structure and ultra-broadband harmonics suppression," *IEEE Access*, vol. 9, pp. 165734-165744, Dec. 2021.

- [6] W. Tang, J. H. Ryu, and H. Kim, "Compact, tunable Wilkinson power divider using tunable synthetic transmission line," *Microw. Opt. Technol. Lett.*, vol. 52, no. 6, pp. 1434-1436, Mar. 2010.
- [7] L. Wu, Z. Sun, H. Yilmaz, and M. Berroth, "A dual-frequency Wilkinson power divider," *IEEE Trans. Microw. Theory Tech.*, vol. 54, no. 1, pp. 278-284, Jan. 2006.
- [8] Y. Sun and A. P. Freundorfer, "Broadband folded Wilkinson power combiner/splitter," *IEEE Microw. Wirel. Compon. Lett.*, vol. 14, no. 6, pp. 295-297, June 2004.
- [9] S. Lotfi, S. Roshani, S. Roshani, and M. S. Gilan, "Wilkinson power divider with band-pass filtering response and harmonics suppression using open and short stubs," *Frequenz.*, vol. 74, no. 5-6, pp. 169-176, May 2020.
- [10] H. S. Vaziri, S. Zarghami, F. Shama, and A. H. Kazemi, "Compact bandpass Wilkinson power divider with harmonics suppression," *AEU - Int. J. Electron. Commun.*, vol. 117, Art. no. 153107, Apr. 2020.
- [11] G. Moloudian, S. R. Miri Rostami, and T. Björninen, "Modified Wilkinson power divider with harmonics suppression and compact size for GSM applications," *Int. J. RF Microw. Comput.-Aided. Eng.*, vol. 30, no. 7, Art. no. e22209, July 2020.
- [12] S. Karimi-khorrami and G. Moloudian, "Design and fabrication of a microstrip lowpass filter with wide tuning range as harmonic suppression with application in Wilkinson power divider," *Analog Integr. Circuits Signal Process.*, vol. 107, no. 1, pp. 155-163, Apr. 2021.
- [13] M. Chongcheawchamnan, N. Siripon, and I. D. Robertson, "Designed and performance of improved lumped-distributed Wilkinson divider topology," *Electron. Lett.*, vol. 37, no.8, pp. 1-2, Apr. 2001.
- [14] P. H. Deng, L. C. Dai, and Y. D. Chen, "Integrating equal-split Wilkinson power dividers and coupled-line bandpass filters," *PIERS Proceedings*, Moscow, Russia, pp. 1249-1253, Aug. 2012.
- [15] S. C. Lin, P. H. Deng, Y. S. Lin, C. H. Wang, and C. H. Chen, "Wide-stopband microstrip bandpass filters using dissimilar quarter-wavelength stepped-impedance resonators," *IEEE Trans. Microw. Theory Tech.*, vol. 54, no. 3, pp. 1011-1018, Mar. 2006.
- [16] M. C. Scardelletti, G. E. Ponchak, and T. M. Weller, "Miniaturized Wilkinson power dividers utilizing capacitive loading," *IEEE Microw. Wirel. Compon. Lett.*, vol. 12, no. 1, pp. 6-8, Jan. 2002.
- [17] M. Kazerooni and A. Cheldavi, "Simulation, analysis, design and applications of array defected microstrip structure (ADMS) filters using rigorously coupled multi-strip (RCMS) method," *Prog. Electromagn. Res.*, vol. 63, pp. 193-207, Jan. 2006.
- [18] C. J. Wang and C. S. Lin, "Compact DGS resonator with improvement of Q-factor," *Electron. Lett.*, vol. 44, no. 15, pp. 908-910, July 2008.
- [19] D. W. Kim, "Small-sized high-power PIN diode switch with defected ground structure for wireless broadband internet," *ETRI J.*, vol. 28, no. 1, pp. 84-86, Feb. 2006.
- [20] R. Phromlounsri, "An improvement of Wilkinson power divider with SITLs compensated microstrip band stop filter," *International Electrical Engineering Congress (iEECON)*, Chonburi, Thailand, pp. 450-453, Oct. 2014.
- [21] J. G. Hong and M. J. Lancaster, *Microstrip Filters for RF/Microwave Applications*, K. Chang, Ed. New York, Wiley, 2001.
- [22] L. Zhu, S. Sun, and R. Li, *Microwave Bandpass Filters for Wideband Communications*, John Wiley & Sons, Inc., New York, 2012.



Ravee Phromlounsri was born in Khon Kaen, Thailand. He received the B.Sc. (Applied Physics in Solid State Electronics) from King Mongkut Institute of Technology, Ladkrabang (KMITL) in 1992, M.Eng. in Electrical Engineering (Telecommunication) from

Mahanakorn University of Technology (MUT) in 2000 and he is currently working toward the D. Eng. in Electrical Engineering in MUT. From 1992 to 2009, he joined MUT as a lecturer in the telecommunication engineering department. Currently, he is an assistant professor in the Department of Computer and Communication Engineering at Udon Thani Rajabhat University. His research interests include IoT/Automation system, and RF/Microwave circuits design.



Somchat Sonasang received the Ph.D. degree in Electrical and Computer Engineering from Mahasarakham University, Maha Sarakham, Thailand, in 2021. He is currently working in the Department of Electronic Technology, Faculty of Industrial Technology, Nakhon

Phanom University, Thailand. His current research interests are microwave circuits, electromagnetic material characterization, non-destructive tests, Rabi oscillation and antenna.