

## Attenuation in Lossy Circular Waveguides

Kim Ho Yeap<sup>1</sup>, Eric Vun Shiung Wong<sup>1</sup>, Humaira Nisar<sup>1</sup>, Kazuhiro Hirasawa<sup>2</sup>,  
and Takefumi Hiraguri<sup>3</sup>

<sup>1</sup>Faculty of Engineering and Green Technology  
Universiti Tunku Abdul Rahman, Jln. Universiti, Bandar Barat, 31900 Kampar, Perak, Malaysia  
yeapkh@utar.edu.my, ewvs1991@lutar.my, humaira@utar.edu.my

<sup>2</sup>University of Tsukuba, Tsukuba, Ibaraki, Japan  
hirasawa@ieee.org

<sup>3</sup>Nippon Institute of Technology, Miyashiro-Machi, Saitama-Ken, Japan  
hira@nit.ac.jp

**Abstract** — We present a simple closed-form approach to calculate the attenuation of waves in lossy circular waveguides. A set of characteristic equations is first derived by matching the tangential fields at the wall boundary with the constitutive properties of the conducting wall material. In order to represent fields' penetration into the lossy wall, a perturbation term is then introduced into the equation. We apply the Finite Difference Method to derive the closed-form expression of the perturbation terms for TE and TM modes. The propagation constant can be found by incorporating the perturbation term into the dispersion relation. Our results show good agreement with those obtained from the rigorous transcendental equations. However, unlike the transcendental approach which is usually laborious in solving, our closed-form approach leads to simpler analysis and, therefore, allows the attenuation to be easily computed.

**Index Terms** — Attenuation constant, circular waveguide, propagation constant, tangential fields, TE modes and TM modes.

### I. INTRODUCTION

Analysis of loss in a circular waveguide has been widely performed using the rigorous transcendental formulation developed by Stratton [1]. Literature which implements Stratton's approach in their analysis includes those in hollow waveguides, dielectric rods, multilayered coated waveguides, as well as, lossy and superconducting waveguides [2-8]. In reality, the tangential fields in a waveguide are continuous across the boundary of the wall. In Stratton's approach, the tangential fields which describe the propagation in the waveguide are matched at the boundary with those penetrated into the lossy conducting wall. A transcendental equation is then

derived by finding the determinant of the coefficients. Although the loss computed using Stratton's approach shows high accuracy, the roots of the solution can only be achieved via a root-finding algorithm. This means that an effective compiler tool, an efficient algorithm and appropriate initial guesses are necessary in order to allow the solution to converge. Hence, the process of solving numerically for the roots of a transcendental equation is usually laborious.

Unlike the transcendental equations, closed-form equations lead to much simpler analysis. The results of the closed-form solutions can easily be obtained in a straight-forward manner and they give more intuitive insights into the inherent behavior of the variable to be solved [9, 10]. However, due to the assumptions made while simplifying the equations to their closed-form expressions, the simplicity found in these equations usually comes at the expense of accuracy. Take for example, the closed-form power-loss method adopted by most textbooks to illustrate the loss in waveguides [11-13]. This method is only valid for certain modes and at a certain range of frequencies  $f$  above its cutoff  $f_c$  [14, 15]. When deriving for its mathematical expressions, the power-loss method assumes wave propagation in a lossless waveguide. Since a lossless waveguide behaves like an ideal high pass filter, it gives infinite attenuation at  $f$  below  $f_c$ . Also, the modes in a lossless waveguide are orthogonal to each other, i.e., each mode can exist separately in the waveguide. In reality, however, the modes in a practical waveguide may co-exist at the same time. Hence, the power-loss method fails to account for the loss arises from the concurrent existence of multiple modes in the waveguide. Clearly, the power-loss method may only be good enough for finding the initial approximation of loss in a waveguide. It may not, however, be appropriate when loss in the waveguide is a

critical factor and accurate prediction of it is necessary.

In [10], we have developed a novel closed-form approach to calculate the loss in both rectangular and circular waveguides with finite conducting wall. The loss in the waveguides is found by solving for the root of a quadratic equation, derived by matching the tangential fields at the boundary with the electrical properties of the wall material. Although the results were found to be accurate and that they agree very well with those obtained from the rigorous approaches (such as Stratton's formulation), the mathematical expressions are long and cumbersome. Here, we extend further the closed-form solution in [10] for the case of a circular waveguide. We will demonstrate that by removing the redundant higher-order variables in the equations, a much simpler set of equations, which give equally accurate results, can be derived.

## II. FORMULATION

Figure 1 shows the geometry of a circular waveguide. At the boundary of the wall, the constitutive properties can be related to the tangential electric fields  $E_t$  and tangential magnetic fields  $H_t$  as [14, 15]:

$$\frac{E_t}{H_t} = \sqrt{\frac{\mu_w}{\varepsilon_w}}, \quad (1)$$

where  $\mu_w$  and  $\varepsilon_w$  are the permeability and the permittivity of the conducting wall material, respectively. The permittivity  $\varepsilon_w$  is complex and is given by [12]:

$$\varepsilon_w = \varepsilon - j \frac{\sigma_w}{\omega}, \quad (2)$$

where  $\omega$  is the angular frequency,  $\sigma_w$  the conductivity of the waveguide wall, and  $\varepsilon$  is the permittivity of free space. The equations obtained from (1) admit non-trivial solutions only when the determinant vanishes. This yields the following characteristic equation for a circular waveguide [14]:

$$\left[ jk_r^2 \sqrt{\frac{\mu_w}{\varepsilon_w}} + \omega \mu_d k_r \frac{J_n'(u)}{J_n(u)} \right] \times \left[ jk_r^2 \sqrt{\frac{\varepsilon_w}{\mu_w}} + \omega \varepsilon_d k_r \frac{J_n'(u)}{J_n(u)} \right] = \left[ \frac{nk_z}{a_r} \right]^2, \quad (3)$$

where  $k_r = \sqrt{k_d^2 - k_z^2}$  is the dispersion relation of the circular waveguide,  $k_z$  the propagation constant,  $J_n(u)$  denotes the Bessel function of the first kind,  $J_n'(u)$  its derivative,  $n$  the order of the Bessel function,  $k_d$ ,  $\mu_d$  and  $\varepsilon_d$  are respectively the wavenumber, permeability and permittivity of the dielectric core material and  $a_r$  is the radius of the circular waveguide. The argument of the Bessel function  $u$  is given as:

$$u = \sqrt{a_r^2 (k_d^2 - k_z^2)}, \quad (4)$$

Since TE and TM modes in a lossless circular waveguide are determined by the roots of  $J_n'(u_{nm}) = 0$

and  $J_n(u_{nm}) = 0$ , respectively [10], (3) can be expanded into the form of a quadratic equation, with  $\frac{J_n'(u)}{J_n(u)}$  or

$\frac{J_n(u)}{J_n'(u)}$  as the variables to be solved for. Here, the  $n$  and  $m$  subscripts denote the  $n$ -th order and  $m$ -th zero of  $J_n(u)$ , respectively. By convention, the  $n$  subscript always represents the number of half-wave field variations in the  $\phi$ -direction; whereas, the  $m$  subscript denotes the number of half-wave field variations in the  $r$ -direction [12]. Hence, different combinations of  $n$  and  $m$  variables produce different TE and TM modes in the waveguide. By expanding (3) and substituting (4) for the lossless case (i.e.,  $u = u_{nm}$ ) into  $k_z$  (i.e.,  $k_z = \sqrt{k_d^2 - \left(\frac{u_{nm}}{a_r}\right)^2}$ ) and  $k_r$  (i.e.,  $k_r = \frac{u_{nm}}{a_r}$ ), the quadratic equations for TE and TM modes can be expressed respectively as (5a) and (5b) below:

$$k_d^2 \left(\frac{u_{nm}}{a_r}\right)^2 \left[ \frac{J_n'(u)}{J_n(u)} \right]^2 + j\omega \left(\frac{u_{nm}}{a_r}\right)^3 \left( \frac{\mu_d}{Z_s} + \varepsilon_d Z_s \right) \left[ \frac{J_n'(u)}{J_n(u)} \right], \quad (5a)$$

$$- \left[ \left(\frac{u_{nm}}{a_r}\right)^4 + \left(\frac{n}{a_r}\right)^2 \left( k_d^2 - \frac{u_{nm}^2}{a_r^2} \right) \right] = 0$$

$$\left[ \left(\frac{u_{nm}}{a_r}\right)^4 + \left(\frac{n}{a_r}\right)^2 \left( k_d^2 - \frac{u_{nm}^2}{a_r^2} \right) \right] \left[ \frac{J_n(u)}{J_n'(u)} \right]^2 - j\omega \left(\frac{u_{nm}}{a_r}\right)^3 \left( \frac{\mu_d}{Z_s} + \varepsilon_d Z_s \right) \left[ \frac{J_n(u)}{J_n'(u)} \right] - k_d^2 \left(\frac{u_{nm}}{a_r}\right)^2 = 0, \quad (5b)$$

where  $Z_s = \sqrt{\frac{\mu_w}{\varepsilon_w}}$  is the surface impedance.

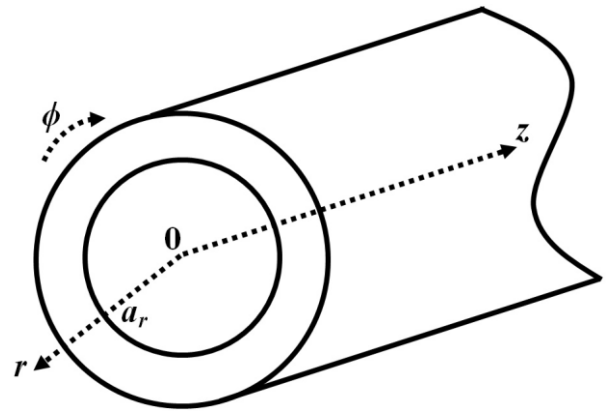

Fig. 1. A circular waveguide.

For a lossy but highly conducting waveguide,  $J_n'(u)$  for TE modes and  $J_n(u)$  for TM modes are close to zero. Hence, the second order of these functions can be

ignored. The solutions to the quadratic equations in (5) can then be found as:

$$\frac{J_n'(u)}{J_n(u)} = \frac{\left(\frac{u_{nm}}{a_r}\right)^4 + \left(\frac{n}{a_r}\right)^2 \left[ k_d^2 - \left(\frac{u_{nm}}{a_r}\right)^2 \right]}{j\omega \left(\frac{u_{nm}}{a_r}\right)^3 \left(\frac{\mu_d}{Z_s} + \varepsilon_d Z_s\right)}, \quad (6a)$$

and,

$$\frac{J_n(u)}{J_n'(u)} = \frac{jk_d^2 \left(\frac{u_{nm}}{a_r}\right)^2}{\omega \left(\frac{u_{nm}}{a_r}\right)^3 \left(\frac{\mu_d}{Z_s} + \varepsilon_d Z_s\right)}, \quad (6b)$$

for TE and TM modes, respectively.

The argument of the Bessel function of a lossy waveguide  $u$  is assumed to be perturbed from that of the lossless case  $u_{nm}$ , i.e.,

$$u = u_{nm} + \delta_u, \quad (7)$$

where  $\delta_u$  is a perturbation term. Substituting (7) into  $J_n'(u)$  for TE modes and  $J_n(u)$  for TM modes, (6) can then be expressed as:

$$\begin{aligned} & J_n'(u_{nm} + \delta_u) \\ &= \frac{\left\{ \left(\frac{u_{nm}}{a_r}\right)^4 + \left(\frac{n}{a_r}\right)^2 \left[ k_d^2 - \left(\frac{u_{nm}}{a_r}\right)^2 \right] \right\} J_n(u)}{j\omega \left(\frac{u_{nm}}{a_r}\right)^3 \left(\frac{\mu_d}{Z_s} + \varepsilon_d Z_s\right)}, \end{aligned} \quad (8a)$$

and,

$$J_n(u_{nm} + \delta_u) = \frac{jk_d^2 \left(\frac{u_{nm}}{a_r}\right)^2 J_n'(u)}{\omega \left(\frac{u_{nm}}{a_r}\right)^3 \left(\frac{\mu_d}{Z_s} + \varepsilon_d Z_s\right)}. \quad (8b)$$

Using the Finite Difference Method (FDM), the first and second derivatives of the Bessel function for a lossless waveguide with argument  $u_{nm}$  can be approximated as follows:

$$J_n(u_{nm} + \delta_u) = J_n'(u_{nm})\delta_u + J_n(u_{nm}), \quad (9a)$$

and,

$$J_n'(u_{nm} + \delta_u) = J_n''(u_{nm})\delta_u + J_n'(u_{nm}). \quad (9b)$$

Substituting (9b) into (8a) and (9a) into (8b) and solving for  $\delta_u$ , we obtain:

$$\begin{aligned} \delta_{uTE} &= \frac{\left\{ \left(\frac{u_{nm}}{a_r}\right)^4 + \left(\frac{n}{a_r}\right)^2 \left[ k_d^2 - \left(\frac{u_{nm}}{a_r}\right)^2 \right] \right\} J_n(u)}{j\omega \left(\frac{u_{nm}}{a_r}\right)^3 \left(\frac{\mu_d}{Z_s} + \varepsilon_d Z_s\right) J_n''(u_{nm})} \\ & - \frac{J_n'(u_{nm})}{J_n''(u_{nm})} \end{aligned}, \quad (10a)$$

and,

$$\begin{aligned} \delta_{uTM} &= \frac{jk_d^2 \left(\frac{u_{nm}}{a_r}\right)^2 J_n'(u)}{\omega \left(\frac{u_{nm}}{a_r}\right)^3 \left(\frac{\mu_d}{Z_s} + \varepsilon_d Z_s\right) J_n'(u_{nm})} \\ & - \frac{J_n(u_{nm})}{J_n'(u_{nm})}, \end{aligned} \quad (10b)$$

where  $\delta_{uTE}$  and  $\delta_{uTM}$  denote respectively the perturbation term  $\delta_u$  for TE and TM modes. Since  $J_n'(u_{nm}) = 0$  for TE modes,  $J_n(u_{nm}) = 0$  for TM modes, and

$J_n''(x) = \left[ \left(\frac{n}{x}\right)^2 - 1 \right] J_n(x)$  [16], by approximating  $J_n(u) \approx$

$J_n(u_{nm})$  and  $J_n'(u) \approx J_n'(u_{nm})$ , the perturbation terms in (10) can then be written as:

$$\delta_{uTE} = \frac{\left(\frac{u_{nm}}{a_r}\right)^4 + \left(\frac{n}{a_r}\right)^2 \left[ k_d^2 - \left(\frac{u_{nm}}{a_r}\right)^2 \right]}{j\omega \left(\frac{u_{nm}}{a_r}\right)^3 \left(\frac{\mu_d}{Z_s} + \varepsilon_d Z_s\right) \left[ \left(\frac{n}{u_{nm}}\right)^2 - 1 \right]}, \quad (11a)$$

and,

$$\delta_{uTM} = \frac{jk_d^2 \left(\frac{u_{nm}}{a_r}\right)^2}{\omega \left(\frac{u_{nm}}{a_r}\right)^3 \left(\frac{\mu_d}{Z_s} + \varepsilon_d Z_s\right)}. \quad (11b)$$

The propagation constant of the lossy waveguide  $k_z$  can be computed by substituting the perturbation terms in (11) and  $k_z$  in (4) into (7), i.e.,

$$k_z = \sqrt{k_d^2 - \left(\frac{u_{nm} + \delta_u}{a_r}\right)^2}. \quad (12)$$

The propagation constant  $k_z$  is a complex variable which consists of the phase constant  $\beta_z$  and attenuation constant  $\alpha_z$ , as shown in (13) below:

$$k_z = \beta_z - j\alpha_z. \quad (13)$$

Hence, by extracting the imaginary part of the propagation constant  $k_z$ , the attenuation in the waveguide can be obtained. For the convenience of casual readers, we outline the final expressions of the attenuation constant for TE modes  $\alpha_{zTE}$  and TM modes  $\alpha_{zTM}$  here. It is worthwhile noting that  $u_{nm}$  for TE and TM modes can be found respectively in Tables 9.1 and 9.2 of [17]:

$$\begin{aligned} \alpha_{zTE} &= \text{Im} \\ & \left[ \sqrt{k_d^2 - \frac{1}{a_r^2} \left\{ u_{nm} - \frac{j \left[ \left(\frac{u_{nm}}{a_r}\right)^4 + \left(\frac{n}{a_r}\right)^2 \left( k_d^2 - \frac{u_{nm}^2}{a_r^2} \right) \right]}{\omega \left(\frac{u_{nm}}{a_r}\right)^3 \left(\frac{\mu_d}{Z_s} + \varepsilon_d Z_s\right) \left[ \left(\frac{n}{u_{nm}}\right)^2 - 1 \right]} \right\}} \right]^2, \end{aligned} \quad (14a)$$

and,

$$\alpha_{zTM} = \text{Im} \left[ \sqrt{k_d^2 - \frac{1}{a_r^2} \left\{ u_{nm} + \frac{jk_d^2 \left( \frac{u_{nm}}{a_r} \right)^2}{\omega \left( \frac{u_{nm}}{a_r} \right)^3 \left( \frac{\mu_d}{Z_s} + \varepsilon_d Z_s \right)} \right\}} \right]^2. \quad (14b)$$

### III. RESULTS AND DISCUSSION

To verify our formulations, we compute and analyze the loss in a hollow circular waveguide with copper wall. The radius of the waveguide is  $a_r = 8.1$  mm. The attenuation constants of the dominant TE<sub>11</sub> mode below and above cutoff  $f_c$  are depicted, respectively in Figs. 2 and 3. As can be seen from the figures, the attenuations predicted by our closed-form approach agree very closely with those by Stratton's rigorous equation. Indeed, it could be observed from Fig. 3 that the attenuations below millimeter wavelengths computed using both methods are almost indistinguishable. Figures 4 and 5 show the attenuation constants of the TM<sub>11</sub> mode. Like the case of the dominant mode, the attenuations below and above cutoff  $f_c$  of the TM<sub>11</sub> mode, obtained from Stratton's and our methods are in very good agreement. It is worthwhile noting that, we have applied the Powell-hybrid root-finding algorithm to solve for Stratton's transcendental equation. The process has been lengthy since the initial guesses were to be constantly refined in order to ensure convergence to the appropriate solution. Unlike, Stratton's approach, however, solutions can be easily found in a straight-forward manner using our closed-form method.

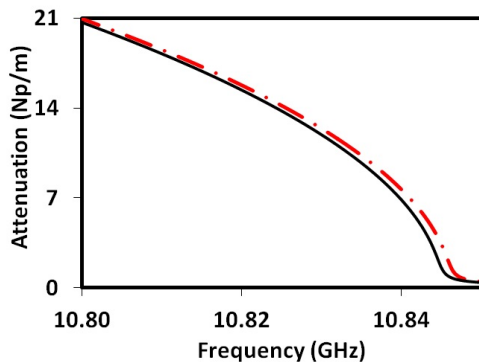

Fig. 2. Attenuation of TE<sub>11</sub> mode below cutoff in an 8.1 mm radius, hollow waveguide with copper wall. The attenuations are computed using our method (solid line) and Stratton's (dashed-dotted line) method.

In order to show that our formulations work equally well in waveguides with different sizes, we compare the attenuation computed from both methods with the waveguide radius  $a_r$  varying from 5 mm to 55 mm. The attenuation of TE<sub>11</sub> and TM<sub>11</sub> modes with respect to the size of the waveguide are depicted, respectively, in Figs. 6 and 7. Since the operating frequency  $f = 100$  GHz is above the cutoff frequencies  $f_c$ , all waves are in

propagating modes. As can be observed from both figures, the attenuation constants obtained from both Stratton's and our method agree very well and are almost indistinguishable. Indeed, the maximum discrepancy found from both results is less than  $1.25 \times 10^{-4}$  Np/m.

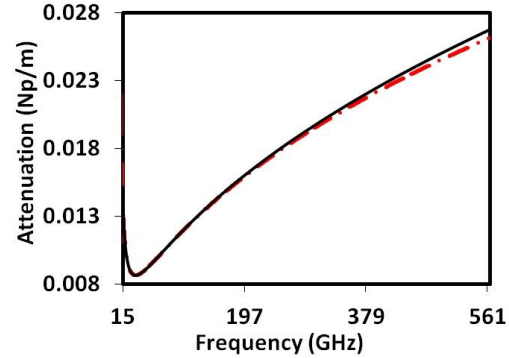

Fig. 3. Attenuation of TE<sub>11</sub> mode above cutoff in an 8.1 mm radius, hollow waveguide with copper wall. The attenuations are computed using our method (solid line) and Stratton's (dashed-dotted line) method.

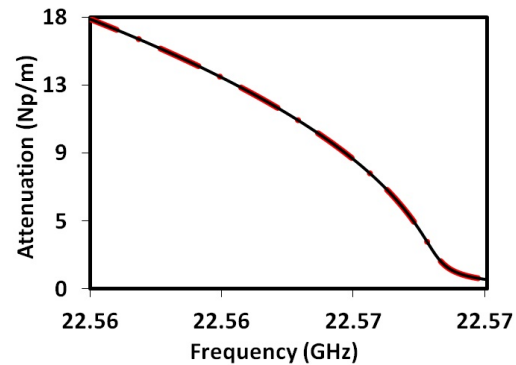

Fig. 4. Attenuation of TM<sub>11</sub> mode below cutoff in an 8.1 mm radius, hollow waveguide with copper wall. The attenuations are computed using our method (solid line) and Stratton's (dashed-dotted line) method.

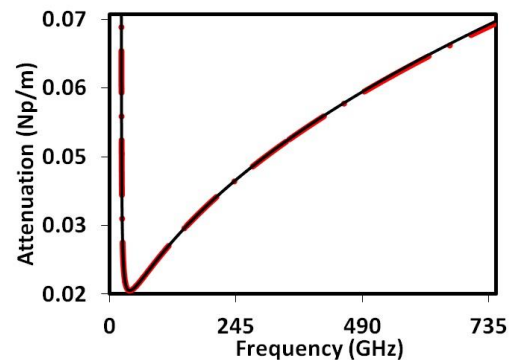

Fig. 5. Attenuation of TM<sub>11</sub> mode above cutoff in an 8.1 mm radius, hollow waveguide with copper wall. The attenuations are computed using our method (solid line) and Stratton's (dashed-dotted line) method.

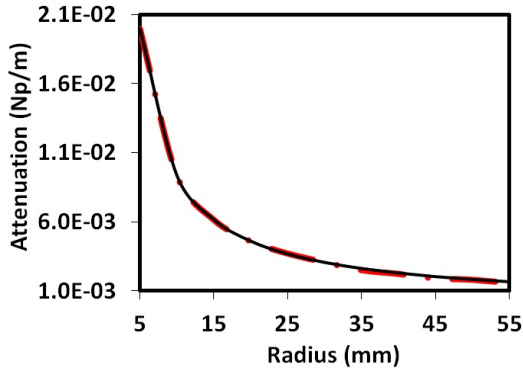

Fig. 6. Attenuation of TE<sub>11</sub> mode when a 100 GHz wave propagates in a hollow waveguide with copper wall. The attenuations are computed using our method (solid line) and Stratton's (dashed-dotted line) method.

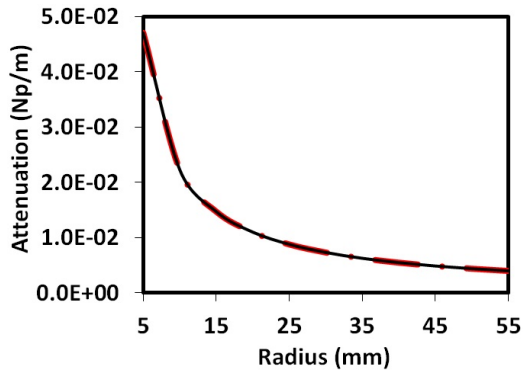

Fig. 7. Attenuation of TM<sub>11</sub> mode when a 100 GHz wave propagates in a hollow waveguide with copper wall. The attenuations are computed using our method (solid line) and Stratton's (dashed-dotted line) method.

#### IV. CONCLUSION

We have developed a set of closed-form formulations for calculating the attenuation of TE and TM modes in a circular waveguide with imperfectly conducting wall. Our approach is based on matching the tangential electric and magnetic fields at the boundary with the electrical properties of the wall material. By neglecting the second-order variables, the roots of the characteristic equation can then be easily expressed in terms of the wavenumbers. Since the behavior of the lossy waveguide is assumed to be perturbed from its lossless case, a perturbation term is introduced into the Bessel function and its derivative. The attenuation constant is found by determining the perturbation terms using the Finite Difference Method and substituting them into the dispersion relation. Our closed-form equations show good agreement with those obtained using Stratton's rigorous approach. Unlike Stratton's transcendental approach, however, our approach leads to simpler and more straight-forward analysis.

#### ACKNOWLEDGMENT

Part of this work has been supported by the FRGS grant (Project: FRGS/2/2013/SG02/UTAR/02/1).

#### REFERENCES

- [1] J. A. Stratton, *Electromagnetic Theory*. 1st ed., McGraw-Hill, 1941.
- [2] K. H. Yeap, C. Y. Tham, G. Yassin, and K. C. Yeong, *Propagation in Lossy Rectangular Waveguides*, in *Electromagnetic Waves/Book 2*, 1st ed., Intech, June 2011.
- [3] J. I. Glaser, "Attenuation and guidance of modes on hollow dielectric waveguides," *IEEE Transactions on Microwave Theory and Techniques (Correspondence)*, vol. 17, pp. 173-176, 1969.
- [4] P. J. B. Claricoats, "Propagation along unbounded and bounded dielectric rods: Part 1. Propagation along an unbounded dielectric rod," *IEEE Monograph*, 409E, pp. 170-176, 1960.
- [5] P. J. B. Claricoats, "Propagation along unbounded and bounded dielectric rods: Part 2. Propagation along a dielectric rod contained in a circular waveguide," *IEEE Monograph*, 410E, pp. 177-185, 1960.
- [6] R. C. Chou and S. W. Lee, "Modal attenuation in multilayered coated waveguides," *IEEE Transactions on Microwave Theory and Techniques*, vol. 36, pp. 1167-1176, 1988.
- [7] K. H. Yeap, A. W. C. Tan, K. C. Lai, and H. Nisar, "A simple analytical method to calculate bending loss in dielectric rectangular waveguides," *ACES Express Journal*, vol. 33, pp. 359-361, 2018.
- [8] K. H. Yeap, J. S. M. Teh, H. Nisar, K. C. Yeong, and K. Hirasawa, "Attenuation in superconducting waveguides," *Frequenz*, vol. 69, pp. 111-117, 2015.
- [9] K. H. Yeap, W. Ismail and K. H. Yeap, "Analytical model for E-shaped microstrip patch antenna," *ACES Journal*, vol. 32, pp. 332-338, 2017.
- [10] K. H. Yeap, E. V. S. Wong, H. Nisar, K. C. Lai, and C. A. Ng, "Attenuation in circular and rectangular waveguides," *Electromagnetics*, vol. 37, pp. 171-184, 2017.
- [11] R. E. Collin, *Field Theory of Guided Waves*. 2nd ed., IEEE Press, New York, 1960.
- [12] D. K. Cheng, *Field and Waves Electromagnetics*. 1st ed., Addison Wesley, 1989.
- [13] R. F. Harrington, *Time-Harmonic Electromagnetic Fields*. 1st ed., Mc-Graw Hill, pp. 66-73, 1961.
- [14] K. H. Yeap, C. Y. Tham, K. C. Yeong, and H. J. Woo, "Wave propagation in lossy and superconducting circular waveguides," *Radioengineering Journal*, vol. 19, pp. 320-325, 2010.
- [15] K. H. Yeap, C. Y. Tham, G. Yassin, and K. C. Yeong, "Attenuation in rectangular waveguides with finite conductivity walls," *Radioengineering J.*, vol. 20, pp. 472-478, 2011.
- [16] T. Abe and Y. Yamaguchi, "Propagation constant

below cutoff frequency in a circular waveguide with conducting medium," *IEEE Transactions on Microwave Theory and Techniques*, vol. 29, pp. 707-712, 1981.

- [17] C. A. Balanis, *Advanced Engineering Electromagnetics*. 1<sup>st</sup> ed., John Wiley and Sons, pp. 472-478, 1989.

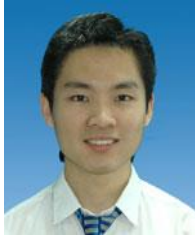

**Kim Ho Yeap** received his B.Eng. (Hons) from Petronas University of Technology in 2004, M.Sc. from National University of Malaysia in 2005 and Ph.D. from Universiti Tunku Abdul Rahman in 2011. He is a Senior Member of the IEEE, a Chartered Engineer registered with the UK Engineering Council and a Professional Engineer registered with the Board of Engineers Malaysia. He has published more than 100 scientific articles which include journal and conference papers, book chapters and books. He is currently an Associate Professor in Universiti Tunku Abdul Rahman. He is also the Editor-in-Chief of *i-manager's Journal on Digital Signal Processing*.



**Eric Vun Shiung Wong** graduated with a first class degree in B.Eng. (Hons) Electronics Engineering at Universiti Tunku Abdul Rahman, Malaysia. He is currently working as a Design Engineer in Motorola Solutions, Inc. He is also pursuing a part time Master degree in Universiti Sains Malaysia at the same time.



**Humaira Nisar** received her B.E. (Honors) in Electrical Engineering from University of Engineering and Technology, Lahore, Pakistan. She received her M.S. degree in Nuclear Engineering from Quaid-e-Azam University, Islamabad, Pakistan. She received her M.S. degree in Mechatronics and Ph.D. in Information and Mechatronics from Gwangju Institute of Science and Technology, Republic of Korea. Currently, she is an Associate Professor at the Department of Electronic Engineering, Universiti Tunku Abdul Rahman, Malaysia. She is also Senior Member of IEEE.



**Kazuhiro Hirasawa** received his Ph.D. degree in Electrical Engineering from Syracuse University, Syracuse, NY, in 1971. From 1967 to 1975, he was with the Department of Electrical and Computer Engineering, Syracuse University. From 1975 to 1977, he was a Consultant on research and development of various antennas. Since 1978, he has been with the University of Tsukuba, Ibaraki, Japan. Currently, he is an Emeritus Professor in University of Tsukuba and an International Collaborative Partner of Universiti Tunku Abdul Rahman, Malaysia. He is also an IEEE Life Fellow and IEICE Fellow.



**Takefumi Hiraguri** received the M.E. and Ph.D. degrees from the University of Tsukuba, Ibaraki, Japan, in 1999 and 2008, respectively. In 1999, he joined the NTT Access Network Service Systems Laboratories, Nippon Telegraph and Telephone (NTT) Corporation. He is now a Professor in Nippon Institute of Technology. He has been engaged in research and development of high speed and high communication quality wireless LANs systems. Hiraguri is a Member of IEICE.