

Radar Noise Floor Method for Occupancy Detection

Pooja Nuti¹, Ehsan Yavari², and Olga Boric-Lubecke¹

¹ Department of Electrical Engineering
University of Hawaii at Manoa, Honolulu, HI 96822, USA
poojan@hawaii.edu, olgabl@hawaii.edu

² Adnoviv LLC
Adnoviv LLC, Honolulu, HI 96822, USA
ehsan@adnoviv.edu

Abstract — A 2.4 GHz continuous wave Doppler radar sensor is utilized to carry out occupancy detection through detection of human presence over an empty room based on time domain root-mean-square (RMS) values. An existing system-on-chip with custom-made baseband board is employed for developing the radio.

Index Terms — Doppler radar, noise level, occupancy detection, Root-Mean-Square (RMS).

I. INTRODUCTION

Previously, occupancy detection has been conducted through detection of large motions or heat detection. Occupancy sensing technology is now moving away from such methods towards vital sign detection. In an effort to design such an occupancy sensor, noise level in conjunction with root-mean-square (RMS) is utilized [4].

Additionally, by rapid increase in global energy use, majority coming from fossil fuels, energy efficiency and conservation are becoming increasingly important. Studies show occupancy sensors can save up to 50% of that energy use [1]. Passive infrared and ultrasonic sensors are the two most common occupancy sensors in the market, however, they suffer from high rates of false alarms due to inconsistent ability to distinguish occupancy [2]. The feasibility of Doppler radar as an occupancy sensor is investigated in [3]. In [4] we investigated the effects of motion on the noise floor of a room and the potential to use that as a measure to discern an occupied room vs. an unoccupied one. In this paper we present experimental results with a human occupant, confirming that this technique can be used to discern human presence.

II. EXPERIMENTAL SETUP

A custom radar with single antenna is used for the measurements (Fig. 1). Radar transmits 2.4 GHz signal.

The radiated signal will be reflected back and received by same antenna. The received signal after down conversion and a conditioning circuit is digitized by the onboard ADC. The digitized signal is sent to a computer via usb port.

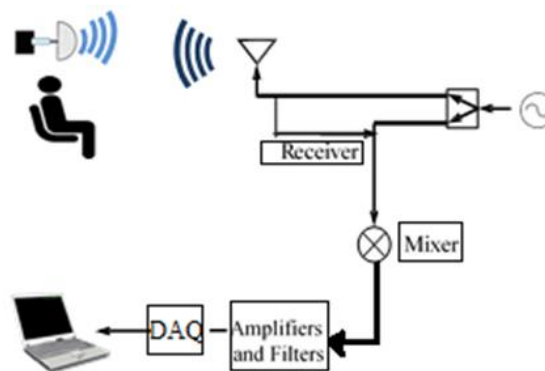

Fig. 1. Block diagram of system.

National Electrical Manufacturers Association (NEMA) standards are adhered to in order to obtain valid data during collection. NEMA requires that occupancy sensors be tested in an indoor area. The indoor area should be split into uniform cells in a grid pattern. By standards, these cells should be 3ft by 3ft in area. The testing environment should be controlled, such that temperature and humidity remain constant. In order to meet these requirements, a room with dimensions 3.5 m by 4.5 m with no windows was utilized. Additionally, the room was broken into 27 cells where the mechanical target/human subject used for vital-sign modeling could be moved through. See Fig. 2 for cell layout in room. Blue tapes in Fig. 3 mark the mechanical target locations throughout the room. The occupancy sensor along with passive infrared/ultrasonic hybrid sensor were wall-mounted. As per standard, the direction of motion

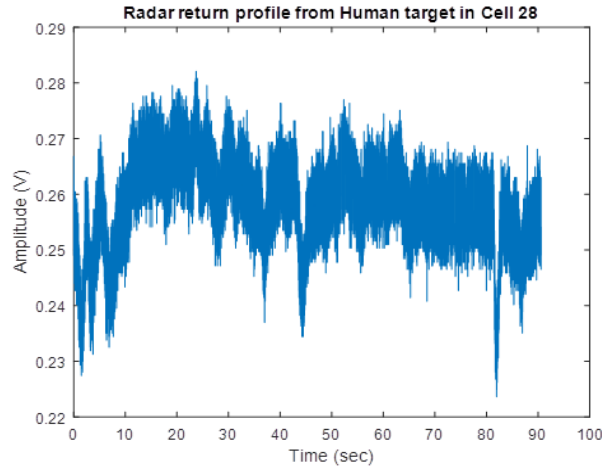

Fig. 5. Radar data from mechanical target in region of weak radar return.

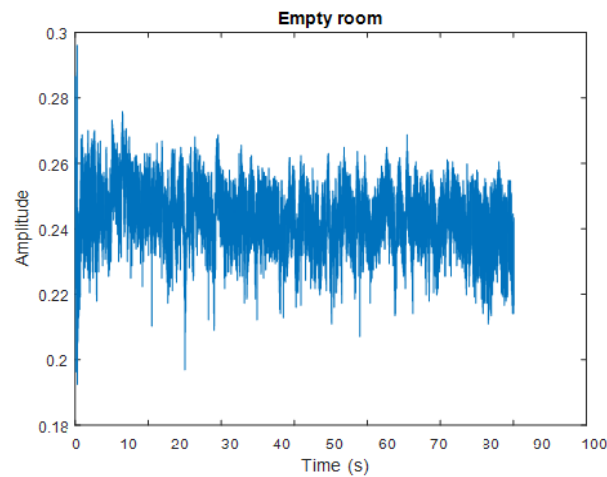

Fig. 6. Radar signal from empty room no mechanical target.

Figure 7 illustrates that despite the raw noise data and radar data with mechanical target seeming qualitatively similar; there is a distinction between their time domain RMS values. The mean of the RMS values of mechanical target return is 0.2523 units while the mean of RMS values of noise (empty room return) is 0.2430 units. These values yield an average difference of 0.0093 units. This difference is low due to the low frequency utilized in data collection (0.2 Hz). Radar baseband filters may have contributed to the low difference between radar signals with the mechanical target and noise data. The difference between mechanical target return and noise is consistent. 92.6% radar signal from the mechanical target could be distinguished from noise, as two RMS values

(corresponding to data collects from two unique cells) from mechanical target are within noise region and therefore undistinguishable.

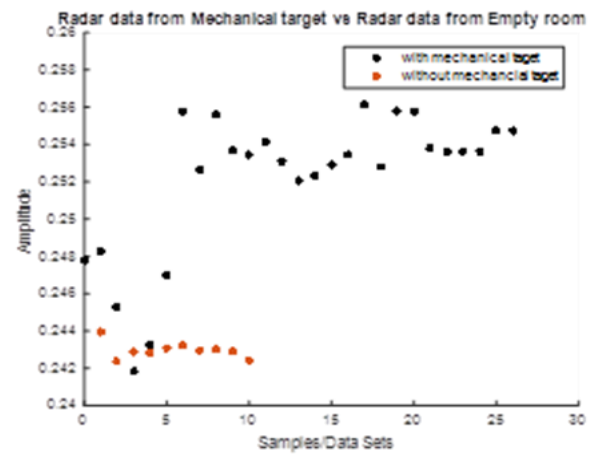

Fig. 7. Time domain RMS with and without mechanical target [4].

B. Results of tests with human subject

There is a qualitative difference between RMS amplitudes of return from a mechanical target in Fig. 7 and a human target (Fig. 10). Using a mechanical target resulted in a more distinct signal level from motion due to the more similar and concentrated amplitudes. In Fig. 10, the RMS amplitudes from the human target are less concentrated than that of the mechanical target. This may be due to the less-controlled frequency of periodic motion observed in human respiration in comparison to the constant frequency that the mechanical target operates at. The result of radar return from human respiration matches the result of radar return from a mechanical target. In these tests, a human was placed in each of the same 27 cells used to test the mechanical target. Similar to the results of the mechanical target, strongest return from the target was yielded from Cell 5 which is located right in front of radar antenna (see Fig. 8). The RMS amplitude of return from this cell was .2495 V. The ability of radar to detect vital signs is observed through the sinusoidal waveform (Fig. 8). This sinusoidal motion corresponds to human respiration. As the human target is moved into cells farther from the line of sight of antenna, radar return degrades. In Fig. 9, Cell 22 yields the lowest RMS amplitude of radar return (.2436 V). This lower amplitude is due to the distance between the radar antenna and test subject, and the location of cell 22 is not in direct path of antenna but rather on a side of the room. Despite the lower amplitude, the presence of a human target is still detected over the mean noise level of .2430 V.

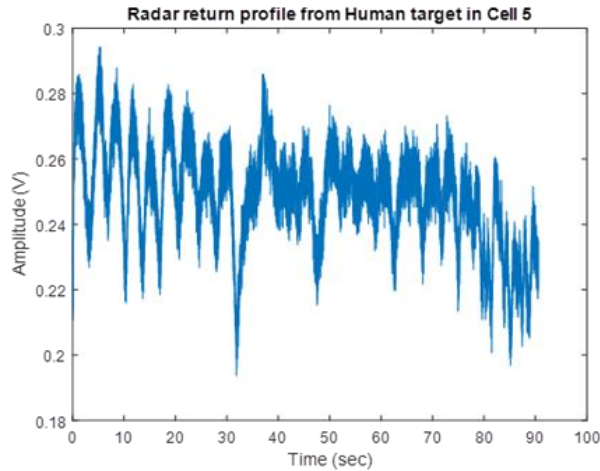

Fig. 8. Human respiration observed through sinusoidal waveform in time-domain.

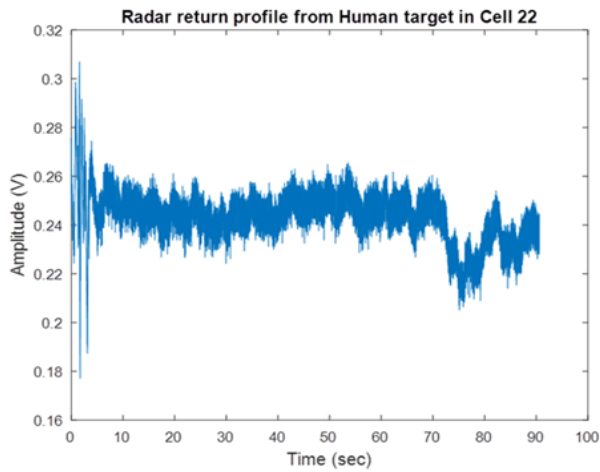

Fig. 9. Radar return from human target at distance away from antenna line of sight. Note similar profile to noise.

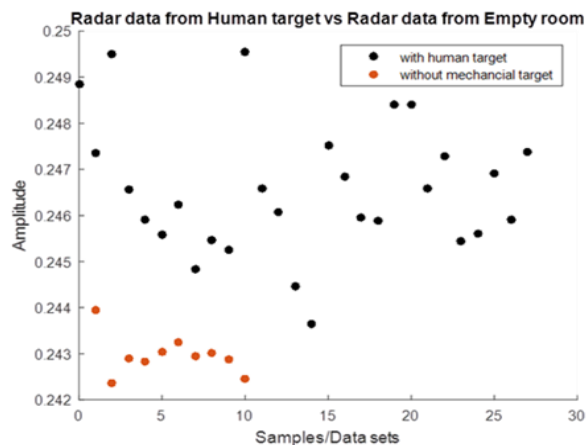

Fig. 10. Return from human target at generally higher signal level than noise level.

IV. CONCLUSION

A Doppler radar occupancy sensor was used for detecting presence. Noise floor of a room is used as a measure to detect occupancy. Experiments were performed to distinguish empty room radar return versus radar return from a mechanical target simulating respiration signal and human target with a resting respiration rate. Tests with a mechanical target agree with tests with a human target. In both cases, stronger human presence is observed in cells closest to the radar. Additionally, both cases result in 93% accuracy in detection of human presence over noise. The gap between RMS values can be utilized to distinguish movement from noise. Future work would focus on testing radar at different frequencies and quantifying the noise floor for the system. Additionally, future work could include modeling performance of radar and finding limits to which this method of occupancy detection is valid by attempting human presence detection over different environments.

ACKNOWLEDGMENT

This work was supported in part by National Science Foundation (NSF) under grant STTR-1417308.

REFERENCES

- [1] X. Guo, D. K. Tiller, G. P. Henze, and C. E. Waters, "The performance of occupancy-based lighting control systems: A review," *Lighting Research and Technology*, vol. 42, no. 4, pp. 415-431, 2010.
- [2] M. Kumar, D. Garge, and R. Zachery, "Multi-sensor fusion strategy to obtain 3-D occupancy profile," *Proceedings of the 31st Annual Conference of the IEEE Industrial Electronics Society (IECON)*, pp. 2083-2088, 2005.
- [3] E. Yavari, H. Jou, V. Lubecke, and O. Boric-Lubecke, "Doppler radar sensor for occupancy monitoring," in *Proc. 2013 IEEE Radio Wireless Symp.*, pp. 316-318, 2013.
- [4] E. Yavari, P. Nuti, and O. Boric-Lubecke, "Occupancy detection using radar noise floor," in *Proc. ICWITS/ACES 2016 Conference*, pp. 152-154, 2016.