

Effects of Room Dimensions on the Frequency Response of Indoor Wave Propagation

Hany M. El-Maghrabi¹, Ahmed M. Attiya², and Essam A. Hashish³

¹Department of Electromechanical
Housing and National Research Center, Cairo, Egypt
helmaghrabi@hbrc.edu.eg

²Department of Microwave Engineering
Electronic Research Institute, Cairo, Egypt
attiya@eri.sci.eg

³Department of Electronics and Electrical Communication
Cairo University, Cairo, Egypt
essamhh@ieee.org

Abstract — In analogy with room acoustics, various aspects of microwave propagation in a room are treated. This paper presents the effect of the room dimensions on the frequency response of a propagating wave inside rooms. It is found by simulation and measurements that room dimensions affect the propagating waves in the rooms and degenerated bands can appear. In critical environments this may cause unwanted coloration effects, which decrease the signal quality. Appropriate choice of room dimensions may reduce the coloration effects of modes. A numerical optimization technique implemented in FEKO software package is used for finding the optimum room dimensions as to achieve the flattest possible frequency response. The effect of the room dimensions on wave propagating in corridors is presented. It is found that the room length has more effects on the frequency response of the signal than the room width for signals excited and transmitted in corridors.

Index Terms — Indoor wave propagation, numerical optimization, optimum room dimensions.

I. INTRODUCTION

With reference to room acoustics, a lot of attention has been drawn to modes in rooms which often lead to extended sound decays and uneven frequency responses [1-3]. In critical listening spaces, this causes unwanted coloration effects that can decrease the sound quality. The problem arises at low frequencies because of the relatively low modal density. Many designers try to overcome the problems of modes coloration by choosing an appropriate room dimensions and by the use of bass absorbers [1], [4-5]. As per literature, it is shown that

there is a close resemblance between room acoustics and room electromagnetics [6-8], since the wavelengths are nearly of the same order for acoustic audio frequencies and part of microwave frequencies, namely in the centimeter range. As room dimensions are much larger than the wavelength, ray-tracing techniques can be used to predict with sufficient precision the radio coverage for large buildings containing a large number of walls between the transmitter and receiver [9-12]. Most indoor studies focus on the coverage and delay spread problems not on the frequency response of the signal. A stochastic approach for indoor diffuse scattering is described in [13] based on path loss distributions. Extracting diffuse scattering from measurements is discussed in [14], and ultra-wideband diffuse scattering is measured in several rooms [15]. The power delay profile was calculated based on averaging plane wave reflection coefficients of smooth surfaces [16]. It is found that the previous work didn't take into consideration the frequency response of the propagating microwave signal inside rooms and the effect of the room dimensions on the signal frequency response which is one of the main objectives of the presented paper. A similar approach as in the present paper was used in [1], while in the former paper the analysis is done in the acoustics band and in the presented paper the analysis is done in the electromagnetic band. Normally, with room limited connectivity it is not expected to find signal resonance in the electromagnetic band while the paper introduced that this can happen with different room dimensions.

The simulation is done using computational electromagnetic software FEKO [24] based on Ray Launching Geometrical Optics (RL-GO) method. The concept of RL-GO modeling is based on the fact that at

high frequencies electromagnetic waves are like rays which travel in straight lines provided that the permittivity of the medium is homogeneous [17]. Geometrical Optics (GO) [18] approximates the field strength at any point as the sum of the field associated with the direct ray from the transmitter to the receiver, plus the field of rays reflected from surfaces. Discontinuities occur when reflection points move off the edges of reflecting surfaces. Geometrical Theory of Diffraction (GTD) and its uniform extension, Uniform Theory of Diffraction (UTD) include rays diffracted from edges, which smooth such discontinuities [19-22].

FEKO's RL-GO [24] method is a ray-based technique that models objects based on optical propagation, reflection and refraction theory [21-23], [25]. Ray-interactions with metallic and dielectric structures are modelled using Huygens sources, placed at each ray, contact point on material boundaries. The ray-launching process is easily controlled, based on the angular spacing (for localized sources) or transverse spacing (for plane wave sources) of the rays and the number of multiple interactions allowed. The simulation is done for 3D analysis for all presented examples.

In order to gain the most benefit from the computational hardware, in FEKO all the solution phases for RL-GO technique have been parallelized, the near- and far-field calculations and also seemingly simple things such as power loss computations. The efficiency of the parallel implementation in FEKO is in the order of 80% to 95%, depending on the problem and the solution phase etc. This means that for a system with 32 cores the run-time would be approximately 26 times (0.8×32) faster than on a sequential run. FEKO also allow the specification of planes of symmetry that may be used to accelerate the simulation and reduce the memory requirements for the solution of a problem.

The purpose of this paper is to demonstrate the applicability of methods applied in room acoustics to microwave propagation in a room and corridors. The paper focuses on the choice of room dimensions to minimize the coloration effects of modes in different bands. It discusses the effect of the room dimensions on signal excited and transmitted in rooms as to avoid any signal resonance which can decrease the signal quality. On the other hand, the authors studied the room dimension effects on signal excited and transmitted in corridors as most of the wireless access points are installed in corridors especially in buildings designed with big corridors as commercial buildings, hospitals and hotels. A Simplex numerical optimization technique implemented in FEKO is used to achieve the flattest possible frequency response. The room dimensions effects on the signal transmitted in indoor corridors are discussed in Sec. 3. Finally, experimental results are conducted in order to verify the presented theory.

II. SIGNAL FREQUENCY RESPONSE INSIDE ROOMS

In acoustics, the room relative dimensions of length, width, and height are acoustical sensitive [1-2]. If plans are being made for constructing such a room, there are usually ideas on floor-space requirements. The literature is full of early quasi-scientific guesses [2-4], and later statistical analyses of room proportions give good mode distribution in the acoustics band. The same problem is studied in the proposed paper while for the microwave band and it is found by simulation and measurements that the dimensions of the room including the length, width, and height are also electromagnetic sensitive and the frequency response of the signal excited inside rooms is sensitive to these dimensions. Consequently, the method for choosing these dimensions is based on a better prediction model based on the proposed ray launching technique.

The modal response of the signal inside room is defined as the frequency spectrum received by an omnidirectional antenna in a corner of the room, when the room is excited by a short dipole with a flat power spectrum placed in the opposite corner as shown in Fig. 1. Using FEKO simulation RL-GO method for 3D analysis, the simulation frequency response of the signal in the presented room layout is shown in Fig. 2, where the room with width, length and height of 5 m, 4.5 m and 3 m, respectively. The room walls permittivity and conductivity are 3 and 0.01 s/m [26], respectively which is corresponding to brick walls. The simulation is done for frequency range of 0.9-2 GHz. The transmitter and receiver is located at 1.5 m from the ground. It can be noted from figure 2 that the modes inside the room at 1.2 GHz are highly degenerated and dark zone can appear in this band which can affect any application running in such band.



Fig. 1. Room layout (top view).

A numerical optimization technique is used to find the best room dimensions as discussed in [1]. The technique is Simplex (Nelder-Mead) method which is implemented in FEKO [24]. The Simplex (Nelder-Mead) algorithm can be categorized as a local or hill-climbing search method, where the final optimum relies strongly on the specified starting point. The maximum and minimum values for the length, width and height are

defined and the dimensions are optimized according to these limits. The analysis is based on calculating the signal modal response for different dimensions within defined limits. Then by comparing the obtained responses it would be possible to determine the ideal response which is judged as the flattest signal response. While it may take time for to complete the optimization process due to big dimensions and high operating frequency, using the parallelization of FEKO can dramatically accelerate the performance.

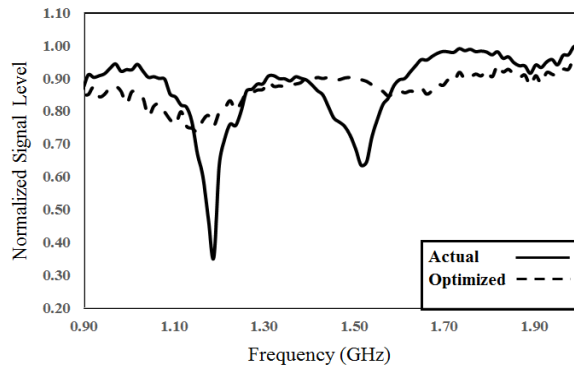

Fig. 2. Modal response of the signal inside room.

The optimization method is applied using FEKO's Simplex (Nealer-Med) method for the above example as shown in Fig. 2. The obtained optimized frequency response is found at a room of width is 4.8 m and length is 4.2 m while the height is 3 m. It can be noted from this result that the frequency response of the signal inside the room with optimized dimensions is better and flatter than the case of original dimensions.

The door effect is simulated for the above room with optimized dimensions. Figure 3 shows the optimized room frequency response with door and without door cases. It can be noted that the door has small effect on the frequency response with optimized dimensions where the door is located on the room side wall with width is 0.9 m and height is 2.1 m as shown in Fig. 4.

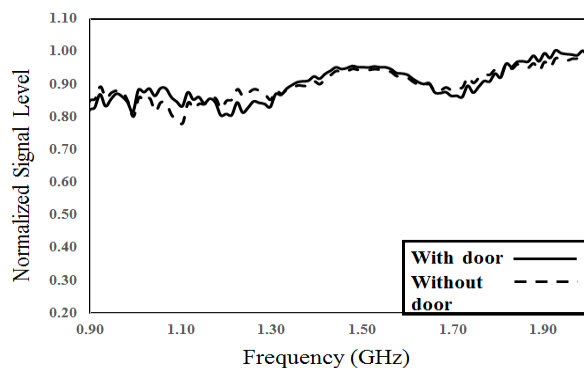

Fig. 3. Door effects on the modal response of the room with optimized dimensions.

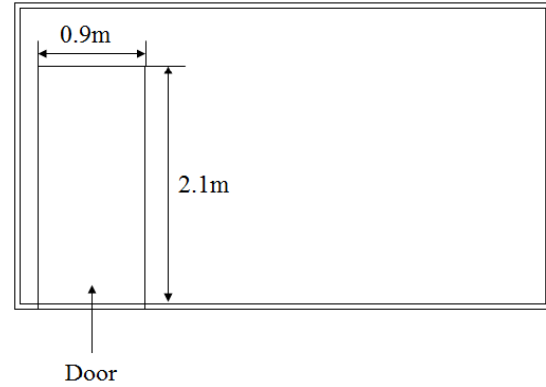

Fig. 4. Room layout with door location (side view).

On the other hand, the modal response is calculated for the same setup but with two different walls materials, Brick with permittivity 3.73 and conductivity 0.462 and Wallboard with permittivity 2.4 and conductivity 0.09 as shown in Fig. 5. It can be noted there is only slight difference in the frequency response for the two materials in the case of the optimized room dimensions.

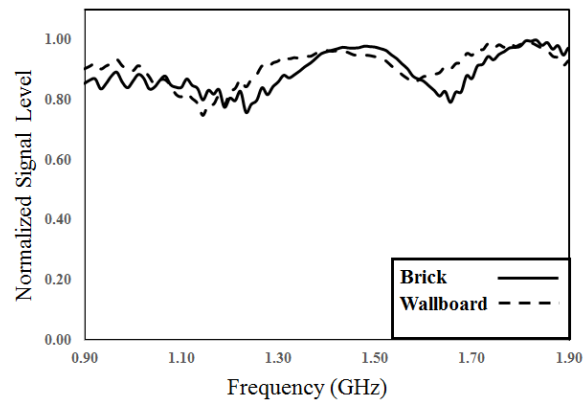

Fig. 5. Walls different materials effects on the modal response of the room with optimized dimensions.

III. ROOM DIMENSIONS EFFECTS ON SIGNAL IN CORRIDOR

The room dimensions can also affect the frequency response and lead to high order modes generation of excited and transmitted signals in indoor corridor with sided rooms like hotels and business buildings. Figure 6 shows the layout structure of two sided rooms in a long corridor section. The room and corridor walls permittivity and conductivity are 3 and 0.01 s/m, respectively [26]. The electric field is calculated along the corridor due to transmitter in the front of the corridor section. The room length and width are changed for two cases and the fields are calculated for each case. The first case the room length is changed while the width is kept constant, where the length is changed from 2.5 m to 10 m and the width

is 4.5 m. The height for both the room and the corridor is 3.9 m and the operating frequency is 0.9 GHz. The source is a vertically polarized dipole at y direction at $z=0.5$ m, $y_{source} = 1.95$ m above the ground and x_{source} at the middle of the corridor, the electric field is calculated at the center line of the corridor at height of 2.25 m.

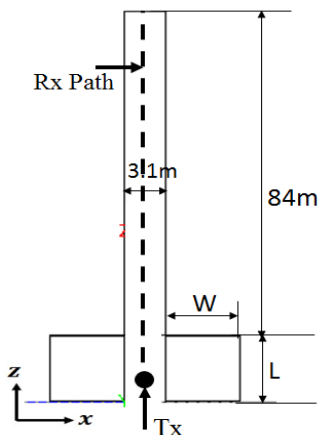

Fig. 6. Long corridor with two sided room layout.

FEKO's RL-GO method is used to calculate the electric field in the corridors using 3D model. The normalized electric field across the center line of the corridor is shown in Fig. 7 for different room lengths, while the frequency response is calculated using Fast Fourier Transform (FFT) as shown in Fig. 8. It can be noted that higher room length, the more high order modes generated and can be detrimental to the signal quality. The choice to calculate the electric field in the center line of the corridor, along x-axis, is to ensure same effect from rooms on both sides by keeping same distance between Rx path and each room side, also in most of indoor wireless designs the transmitter is kept in the corridor center for signal broadcasting equally on both room sides.

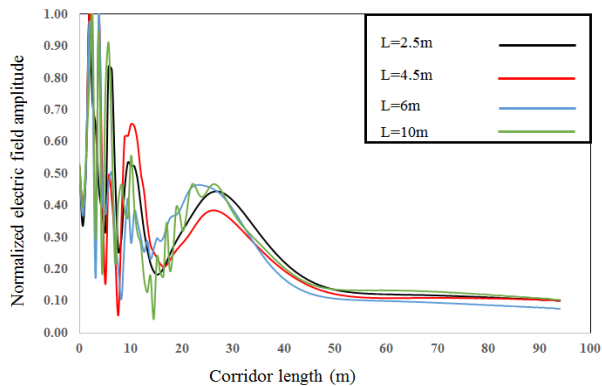

Fig. 7. Normalized electric field distribution at the corridor center with different room lengths.

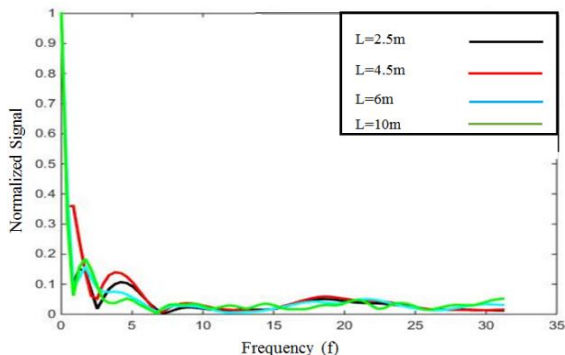

Fig. 8. Frequency response using FFT of electric field distribution at the corridor center with different room lengths.

On the other hand, the same analysis is repeated with changing the width of the room while the length is kept constant. The normalized electric field across the center line of the corridor is shown in Fig. 9 for different room widths, while the FFT for the signal is shown in Fig. 10. It can be noted that changing the room width has lower effect on the signal propagated in corridor.

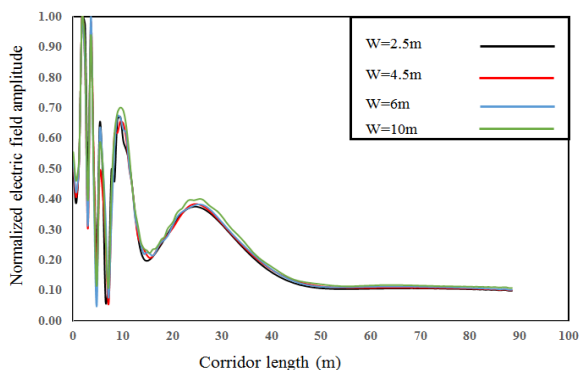

Fig. 9. Normalized electric field distribution at the corridor center for different room widths.

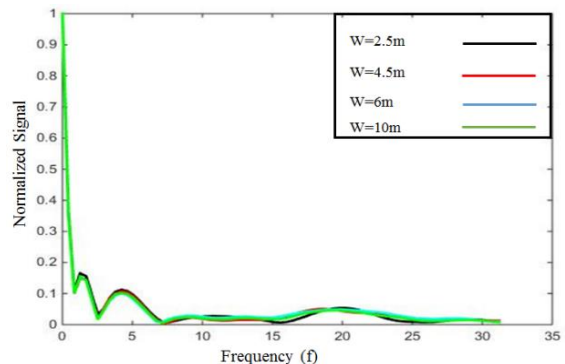

Fig. 10. Frequency response using FFT of electric field distribution at the corridor center for different room widths.

IV. MEASUREMENTS

In this section sample results are presented to verify the accuracy of the present approach for the signal propagated inside room and to verify the accuracy FEKO simulation model. The proposed measurements is used to study the simple wave propagating inside rooms in indoor residential building.

This simple scenario of a room is verified experimentally at frequency range 0.5-1.4 GHz. The scenario was done in room inside residential building with brick walls. The experimental setup consists of two wooden carts. One cart is used to hold the transmitter and the other one is used to hold the receiving antenna and computer for receiving data collection and analysis as shown in Fig. 11. Handheld RF Signal Generator (RFEGEN 1.12) with dipole antenna with gain of 2.2 dBi is used as transmitter while the receiver is RF Viewer wireless USB dongle and data is collected using computer software package RF spectrum analyzer (TOUCHSTONE PRO). The transmitting and receiving antennas are kept vertically polarized. The measurements were taken with the transmitter is located at one corner of the room while the receiver on the other corner of the room as shown in Fig. 12. The room dimensions are highlighted in Fig. 12. The height of the room is 2.7 m. The height of both transmitting and receiving antennas is kept 60 cm above the ground. Figure 13 shows a comparison between the measured received power in dBm and calculated power by FEKO RL-GO method. Good agreement between the measured and calculated power is obtained. The slight differences can be explained due to errors in the manual positioning of the receiving antenna and differences due to the boundary conditions of the actual room. The calculated error between the model and measured results is about 11.3%. It can be noted that the room has degenerated band at 1.2 GHz which can decrease the signal quality in this band and affect any running application in this band. Electromagnetic signal resonance due to room dimensions should be checked by room designers especially for buildings designed with big corridors as commercial buildings, hospitals and hotels to avoid probability of resonance in critical bands as GSM, WIFI which can cause service outage and single degradation

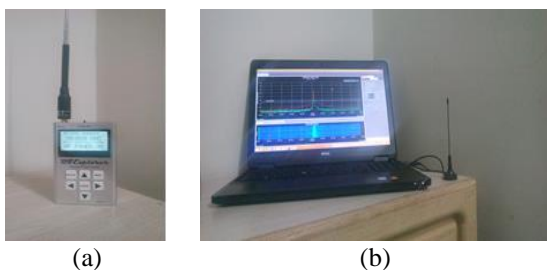

Fig. 11. Measurement setup: (a) transmitter and (b) receiver.

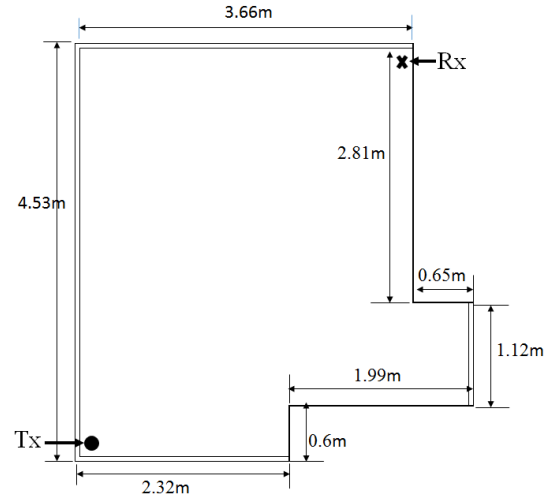

Fig. 12. Room layout.

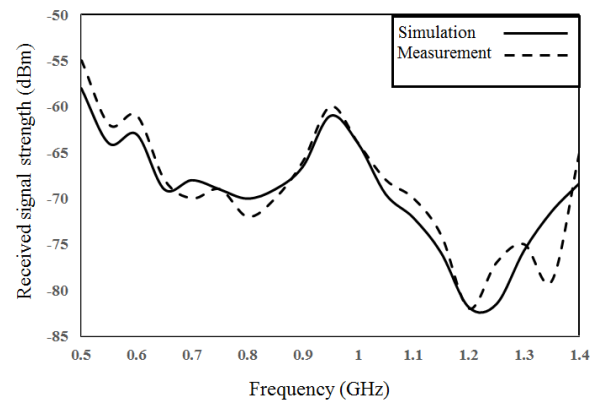

Fig. 13. Received power (dBm) at the room corner.

V. CONCLUSION

The effect of the room dimensions on the frequency response of a propagating wave inside rooms and long corridors is presented. It is shown that the electromagnetic propagation inside rooms is sensitive to the room dimensions. Degenerated modes can appear with variety of room dimensions. An optimization procedure is used for choosing the best room dimensions with maximum flatten modal response. It is found by simulation that the room length has a greater effect on the signal frequency response which is excited and transmitted in corridors than the room width. This can lead to generate of high order modes which can decrease the signal quality. The concept helps the designers to avoid signal resonance due room dimensions. Finally, measurements are introduced to verify the proposed idea for the effect of the room dimension on the signal quality.

REFERENCES

- [1] T. Cox and P. D'Antonio, "Determining optimum room dimensions for critical listening environments:

- A new methodology," *AES Convention*, paper no. 5353, May 2001.
- [2] Y. Tang, M. Cooke, B. Fazenda, and T. Cox, "A glimpse-based approach for predicting binaural intelligibility with single and multiple maskers in anechoic conditions," *INTERSPEECH*, 2015.
- [3] C. L. S. Gilford, "The acoustic design of talk studios and listening rooms," *J. Audio. Eng. Soc.*, no. 27, pp. 17-31, 1979.
- [4] M. Loudon, "Dimension ratios of rectangular rooms with good distribution of eigentones," *Acustica*, no. 24, pp. 101-104, 1971.
- [5] R. Walker, "Optimum Dimension Ratios for Small Rooms," Preprint 4191, *Convention of the AES*, 5/1996.
- [6] J. Andersen, J. Nielsen, G. Pedersen, G. Bauch, and J. Herdin, "Room electromagnetics," *IEEE Antennas and Propagation Magazine*, pp. 27-33, April 2007.
- [7] J. Andersen, K. Chee, M. Jacob, G. Pedersen, and T. Kürner, "Room electromagnetics applied to an aircraft cabin with passengers," *IEEE Transactions on Antennas and Propagation*, pp. 2472-2480, 2012.
- [8] G. Steinböck, T. Pedersen, B. H. Fleury, W. Wang, and R. Raulefs, "Experimental validation of the reverberation effect in room electromagnetics," *IEEE Transactions on Antennas and Propagation*, pp. 2041-2053, 2015.
- [9] S. Sidhu, A. Khosla, and A. Sharma, "Implementation of 3-D ray tracing propagation model for indoor wireless communication," *International Journal of Electronics Engineering*, vol. 4, no. 1, pp. 43-47, 2012.
- [10] T. Sarkar, J. Zhong, K. Kim, A. Medouri, and M. Salazar-Palma, "A survey of various propagation models for mobile communication," *IEEE Antennas and Propagation Magazine*, vol. 45, no. 3, pp. 51-82, June 2003.
- [11] C. Trueman, D. Davis, B. Segal, and W. Muneer, "Validation of fast site-specific mean-value models for indoor propagation," *ACES Journal: Applied Computational Electromagnetics Society*, vol. 24, no. 3, pp. 312-323, June 2009.
- [12] J. McKown and R. Hamilton, "Ray tracing as a design tool for radio networks," *IEEE Network*, vol. 6, pp. 27-30, November 1991.
- [13] D. Ullmo and H. Baranger, "Wireless propagation in buildings: A statistical scattering approach," *IEEE Trans. on Vehicular Technology*, vol. 48, no. 3, pp. 947-955, May 1999.
- [14] A. Richter and R. Thomä, "Joint maximum likelihood estimation of specular paths and distributed diffuse scattering," *Proc. IEEE Vehicular Technology Conference*, Sweden, vol. 1, pp. 11-15, May 2005.
- [15] J. Kunisch and J. Pamp, "Measurement results and modeling aspects for the UWB radio channel," *Proc. IEEE Conference on Ultra Wideband Systems and Technologies*, pp. 19-23, May 2002.
- [16] C. L. Holloway, M. C. Cotton, and P. McKenna, "A model for predicting the power delay profile characteristics inside a room," *IEEE Transactions on Vehicular Technology*, vol. 48, no. 4, pp. 1110-1120W, July 1999.
- [17] W. K. Tam and V. N. Tran, "Propagation modeling for indoor wireless communication," *Electronics & Communication Engineering Journal*, pp. 221-228, October 1995.
- [18] K. Morris, "Electromagnetic theory and geometrical optics," New York: Courant Institute of Mathematical Sciences, New York University, 1962.
- [19] C. A. Balanis, *Advanced Engineering Electromagnetics*. 2nd edition, Wiley, 2012.
- [20] D. Derek A. McNamara, C. W. Carl, W. I. Pistorius, and J. A. G. Malherbe, *Introduction to The Uniform Geometrical Theory of Diffraction*. Artech House, 1990.
- [21] J. B. Keller, "Geometrical theory of diffraction," *J. Opt. Soc. Amer.*, vol. 52, pp. 116-130, February 1962.
- [22] R. Akl, D. Tummala, and X. Li, "Indoor propagation modeling at 2.4 GHz for IEEE 802.11 networks," *The Six IASTED International Multi-Conference on Wireless and Optical Communication*, Banff, AB, Canada, July 3-5, 2006.
- [23] R. G. Vaughan and J. Bach Andersen, "Channels, Propagation and Antennas for Mobile Communications," The Institution of Engineering and Technology, 2003.
- [24] FEKO Suite 7.0, Altair Engineering, 2014.
- [25] L. Azpilicueta, M. Rawat, K. Rawat, F. Ghannouchi, and F. Falcone, "Convergence analysis in deterministic 3D Ray launching radio channel estimation in complex environments," *ACES Journal*, vol. 29, no. 4, April 2014.
- [26] J. Leung, "Hybrid Waveguide Theory-Based Modeling of Indoor Wireless Propagation," M.Sc. Dissertation, Department of Electrical and Computer Engineering, University of Toronto, 2009.



Hany M. El-Maghrabi received the B.Sc. degree, with Honor Degree, M.Sc. and Ph.D. degrees in Electrical Engineering from the Cairo University (Egypt). El-Maghrabi has got a position of Research Assistant in Housing and Building National Research Center (HBNRC), Institute of Electromechanical, Department of Communication (Egypt). He became Researcher at HBNRC at 2017. He has co-authored technical journal article and conference papers. El-Maghrabi has an experience in electromagnetics, antennas, microstrip structures, numerical methods, wave propagation and their applications in microwave. El-Maghrabi was awarded The Best Paper in NRSC 2015.



Ahmed M. Attiya M.Sc. and Ph.D. Electronics and Electrical Communications, Faculty of Engineering, Cairo University at 1996 and 2001 respectively. He joined Electronics Research Institute as a Researcher assistant at 1991. In the period from 2002 to 2004 he was a Postdoc in

Bradley Department of Electrical and Computer Engineering at Virginia Tech. In the period from 2004 to 2005 he was a Visiting Scholar in Electrical Engineering Dept. in University of Mississippi. In the period from 2008 to 2012 he was a Visiting Teaching Member in King Saud University. He is currently Full Professor and the Head of Microwave Engineering Dept. in Electronics Research Institute. He is also the Director of Nanotechnology Lab. in Electronics Research Institute.



Essam A. Hashish (M'96) received the B.Sc., M.Sc., and Ph.D. degrees from the Electronics and Communications Department, Faculty of Engineering, Cairo University, Giza, Egypt, in 1973, 1977, and 1985, respectively. He is currently a Professor with the Electromagnetics Group at the same department. His main interest is electromagnetic remote sensing, wave propagation, and microwave antennas.